

# Fidelize: RNDAC

Precision Digital-to-Analog Converter

RUPERT NEVE DESIGNS



# Operations Manual

# Important Safety Instructions

1. Read these instructions.
2. Keep these instructions.
3. Heed all warnings.
4. Follow all instructions.
5. Do not use this apparatus near water.
6. Clean only with a dry cloth.
7. Do not block any ventilation openings. Install in accordance with the manufacturer's instructions.
8. Do not install near any heat sources such as radiators, heat registers, stoves, or other apparatus (including amplifiers) that produce heat.
9. Do not defeat the safety purpose of the polarized or grounding-type plug. A polarized plug has two blades with one wider than the other. A grounding-type plug has two blades and a third grounding prong. The wide blade or the third prong are provided for your safety. If the provided plug does not fit into your outlet, consult an electrician for replacement of the obsolete outlet.
10. Protect the power cord from being walked on or pinched particularly at plugs, convenience receptacles, and the point where they exit from the apparatus.
11. Only use attachments/accessories specified by the manufacturer.
12. Use only with a cart, stand, tripod, bracket, or table specified by the manufacturer, or sold with the apparatus. When a cart is used, use caution when moving the cart/apparatus combination to avoid injury from tip-over.
13. Unplug this apparatus during lightning storms or when unused for long periods of time.
14. Refer all servicing to qualified service personnel. Servicing is required when the apparatus has been damaged in any way, such as power-supply cord or plug is damaged, liquid has been spilled or objects have fallen into the apparatus, the apparatus has been exposed to rain or moisture, does not operate normally, or has been dropped.
15. This apparatus shall not be exposed to dripping or splashing, and no object filled with liquids, such as vases or beer glasses, shall be placed on the apparatus.
16. Do not overload wall outlets and extension cords as this can result in a risk of fire or electric shock.
17. This apparatus has been designed with Class-I construction and must be connected to a mains socket outlet with a protective earthing connection (the third grounding prong).
18. This apparatus has been equipped with a rocker-style AC mains power switch. This switch is located on the rear panel and should remain readily accessible to the user.
19. The MAINS plug or an appliance coupler is used as the disconnect device, so the disconnect device shall remain readily operable.



**20. NOTE:** This equipment has been tested and found to comply with the limits for a Class B digital device, pursuant to part 15 of the FCC Rules. These limits are designed to provide reasonable protection against harmful interference in a residential installation. This equipment generates, uses, and can radiate radio frequency energy and, if not installed and used in accordance with the instructions, may cause harmful interference to radio communications. However, there is no guarantee that interference will not occur in a particular installation. If this equipment does cause harmful interference to radio or television reception, which can be determined by turning the equipment off and on, the user is encouraged to try to correct the interference by one or more of the following measures:

- Reorient or relocate the receiving antenna.
- Increase the separation between the equipment and the receiver.
- Connect the equipment into an outlet on a circuit different from that to which the receiver is connected.
- Consult the dealer or an experienced radio/TV technician for help.

**CAUTION:** Changes or modifications to this device not expressly approved by Rupert Neve Designs LLC, could void the user's authority to operate the equipment under FCC rules.

**21.** This apparatus does not exceed the Class A/Class B (whichever is applicable) limits for radio noise emissions from digital apparatus as set out in the radio interference regulations of the Canadian Department of Communications.

**ATTENTION** — *Le présent appareil numérique n'émet pas de bruits radioélectriques dépassant les limites applicables aux appareils numériques de class A/de class B (selon le cas) prescrites dans le règlement sur le brouillage radioélectrique édicté par les ministere des communications du Canada.*

**22.** Exposure to extremely high noise levels may cause permanent hearing loss. Individuals vary considerably in susceptibility to noise-induced hearing loss, but nearly everyone will lose some hearing if exposed to sufficiently intense noise for a period of time. The U.S. Government's Occupational Safety and Health Administration (OSHA) has specified the permissible noise level exposures shown in the following chart. According to OSHA, any exposure in excess of these permissible limits could result in some hearing loss. To ensure against potentially dangerous exposure to high sound pressure levels, it is recommended that all persons exposed to equipment capable of producing high sound pressure levels use hearing protectors while the equipment is in operation. Ear plugs or protectors in the ear canals or over the ears must be worn when operating the equipment in order to prevent permanent hearing loss if exposure is in excess of the limits set forth here:

	<b>CAUTION AVIS</b>	
RISK OF ELECTRIC SHOCK. DO NOT OPEN RISQUE DE CHOC ELECTRIQUE. NE PAS OUVRIR		
CAUTION: TO REDUCE THE RISK OF ELECTRIC SHOCK DO NOT REMOVE COVER (OR BACK) NO USER-SERVICEABLE PARTS INSIDE. REFER SERVICING TO QUALIFIED PERSONNEL.		
ATTENTION: POUR EVITER LES RISQUES DE CHOC ELECTRIQUE, NE PAS ENLEVER LE COUVERCLE. AUCUN ENTRETIEN DE PIECES INTERIEURES PAR L'USAGER. CONFIER L'ENTRETIEN AU PERSONNEL QUALIFIE.		
AVIS: POUR EVITER LES RISQUES D'INCENDIE OU D'ELECTROCUTION, N'EXPOSEZ PAS CET ARTICLE A LA PLUIE OU A L'HUMIDITE.		

The lightning flash with arrowhead symbol within an equilateral triangle is intended to alert the user to the presence of uninsulated "dangerous voltage" within the product's enclosure, that may be of sufficient magnitude to constitute a risk of electric shock to persons.

*Le symbole éclair avec point de flèche à l'intérieur d'un triangle équilatéral est utilisé pour alerter l'utilisateur de la présence à l'intérieur du coffret de "voltage dangereux" non isolé d'ampleur suffisante pour constituer un risque d'électrocution.*

The exclamation point within an equilateral triangle is intended to alert the user of the presence of important operating and maintenance (servicing) instructions in the literature accompanying the appliance.

*Le point d'exclamation à l'intérieur d'un triangle équilatéral est employé pour alerter les utilisateurs de la présence d'instructions importantes pour le fonctionnement et l'entretien (service) dans le livret d'instruction accompagnant l'appareil.*

This symbol indicates that this product must not be disposed of with other waste. Instead, it is your responsibility to dispose of your waste equipment by handing it over to a designated collection point for the recycling of waste electrical and electronic equipment. The separate collection and recycling of your waste equipment at the time of disposal will help conserve natural resources and ensure that it is recycled in a manner that protects human health and the environment. For more information about where you can drop off your waste equipment for recycling, please contact your local city recycling office or the dealer from whom you purchased the product.

Duration, per day, in hours	Sound Level, dBA, Slow Response	Typical Example
8	90	Duo in small club
6	92	
4	95	Subway Train
3	97	
2	100	Typical music via head phones
1.5	102	
1	105	Siren at 10 m distance
0.5	110	
0.25 or less	115	Loudest parts at a rock concert

**WARNING** — To reduce the risk of fire or electric shock, do not expose this apparatus to rain or moisture.

# Table of Contents

Introduction	1
Block Diagram	1
Front Panel	2
Rear Panel	3
RNDAC Features	4
USB Audio Setup	7
DSD Playback	10
Digital Filter Options	10
Micro-USB Firmware Update	11
Specifications	17
Frequency Response Graphs	19
Limited Warranty	23

# Rupert Neve Designs Fidelice RNDAC: Precision DAC

Thank you for purchasing the Rupert Neve Designs Fidelice RNDAC: Precision Digital-to-Analog Converter. We hope you enjoy using this product as much as we have enjoyed designing and building it. The RNDAC features custom Rupert Neve Designs transformer-coupled outputs, Class-A analog signal paths, high-quality AKM Digital-to-Analog Conversion and a precision reference headphone amplifier.

Guided by the Rupert Neve Designs engineering philosophy, we were able to produce wide-bandwidth, low-noise and low-distortion analog signal paths that compliment the RNDAC's Digital-to-Analog Conversion, ultimately providing the listener with true high-fidelity reproduction.

## RNDAC Block Diagram

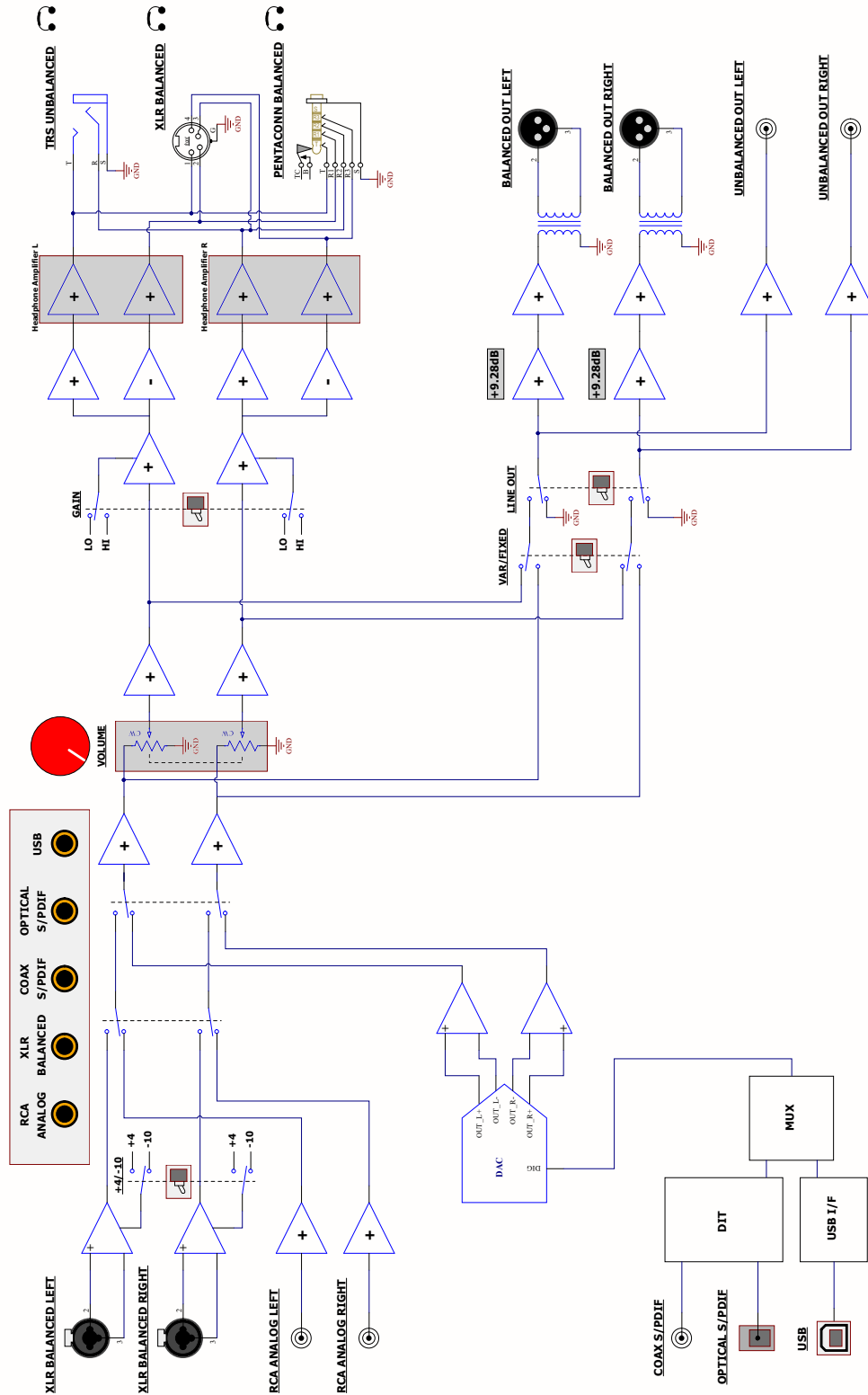

# RNDAC Front Panel

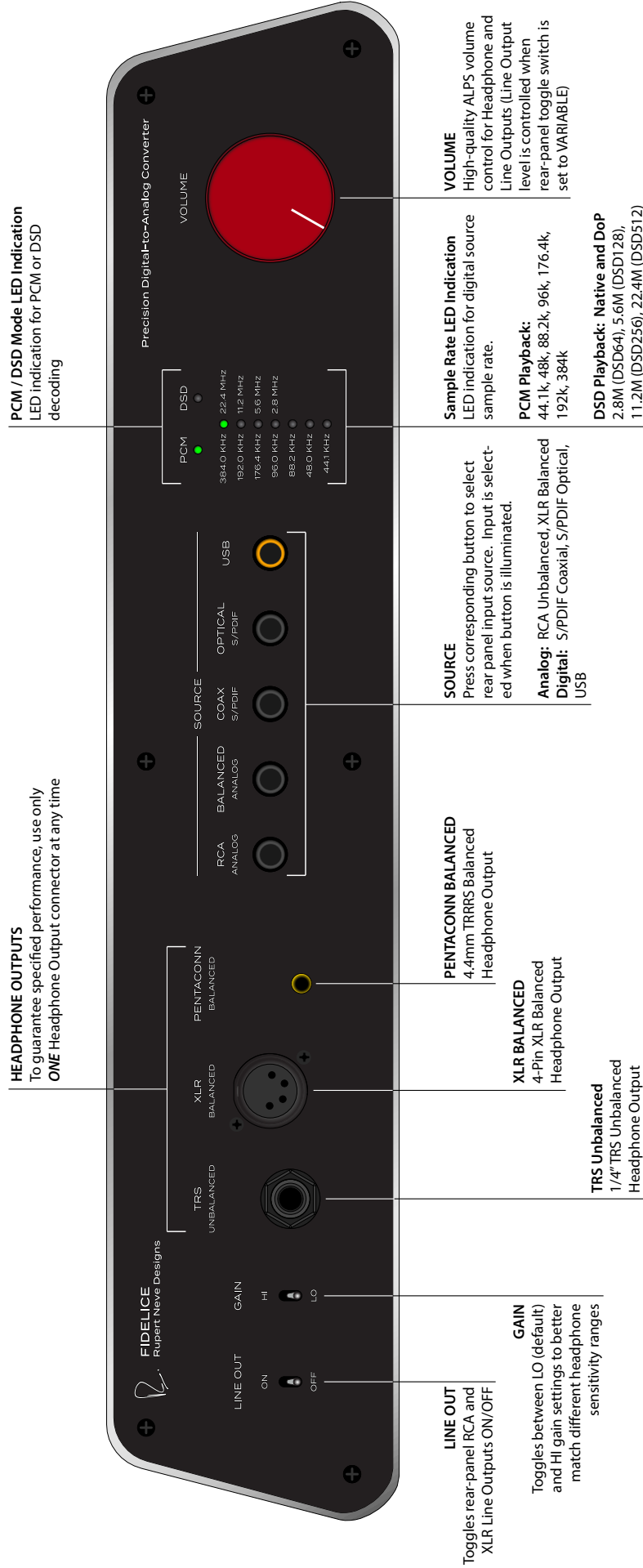

# RNDAC Rear-Panel

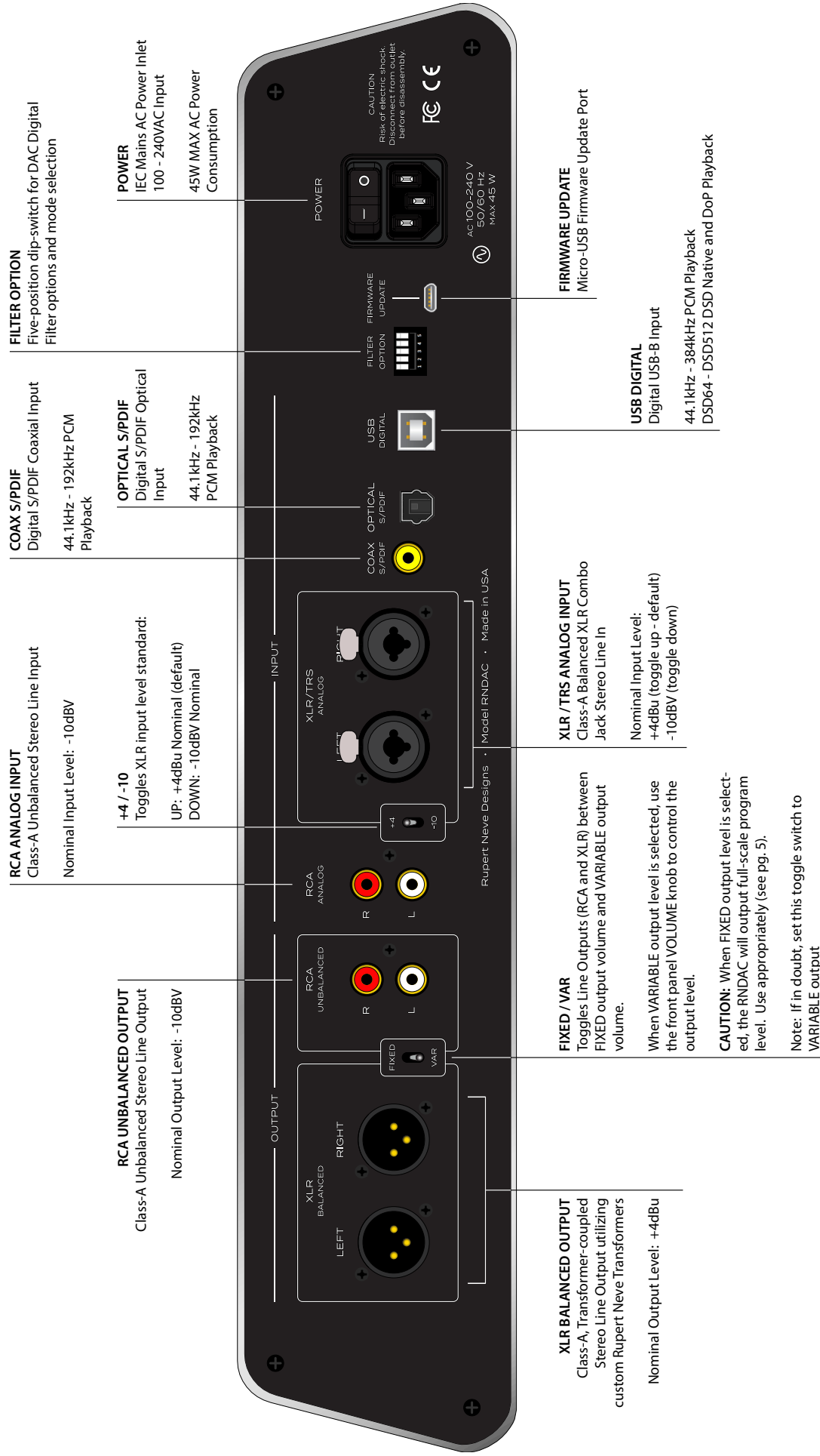

# RNDAC Front-Panel Features

## Line Out

The LINE OUT switch toggles the RNDAC's rear-panel BALANCED XLR and UNBALANCED RCA line outputs ON or OFF.

## Gain

The GAIN switch toggles between LO and HI gain output for the headphone amplifier to allow the user to better optimize their listening setup for the variance in headphone impedance and efficiency between manufacturers.

## Precision Headphone Amplifier

The RNDAC Precision Headphone Amplifier offers three (3) headphone output jacks: **1/4" TRS Unbalanced, XLR 4-Pin Balanced** and **4.4mm TRRRS Pentaconn Balanced**.

**TRS (1/4") Unbalanced** is one of the most common types of headphone connector. If your headphones are equipped with the smaller 3.5mm TRS standard, then you will need to use a **3.5mm to 1/4" TRS adapter** to connect to the RNDAC's Unbalanced Headphone Output.

The Balanced headphone outputs are reserved for the **XLR 4-Pin** and **4.4mm TRRRS Pentaconn** standards. If you are unsure about what connector you have on your headphones, please contact [service@rupertneve.com](mailto:service@rupertneve.com) for further information before operating the RNDAC headphone amp.

NOTE: All three headphone outputs are in *parallel*, so the user should take care to connect only **one** pair of headphones at a time. In addition, the **lowest** recommended headphone impedance is **16Ω**. This will ensure the specified headphone amplifier performance and provide the best possible listening experience.

## Source Select

The front-panel SOURCE selection buttons allow the user to randomly select between the five (5) available RNDAC inputs: RCA Analog, XLR Balanced, COAX S/PDIF, Optical S/PDIF, and USB Digital. When first powering on the RNDAC, the front panel will run through its startup sequence and then SOURCE selection will become active. After the RNDAC boot sequence, only one (1) SOURCE select button should be illuminated.

## Sample Rate Indication

Sample Rate Indication is provided on the RNDAC front-panel for the user. The indicated PCM Sample Rates include: 44.1 kHz, 48 kHz, 88.2 kHz, 96 kHz, 176.4 kHz, 192 kHz, and 384 kHz.

The RNDAC's indicated DSD rates include: DSD64 (2.8 MHz / Single), DSD128 (5.6 MHz / Double), DSD256 (11.2 MHz / Quad), and DSD512 (22.4 MHz / Octa).

## PCM / DSD Mode Indication

PCM and DSD mode LED indication is provided on the RNDAC front-panel for the user. When playing back PCM content at one of the RNDAC's indicated PCM Sample Rates, the corresponding PCM LED will illuminate. When playing back DoP (DSD over PCM) or Native DSD, the DSD LED will illuminate.

## Volume

The RNDAC utilizes a stereo ALPS potentiometer for VOLUME control. The VOLUME knob allows the user to adjust the output volume of the RNDAC headphone amp. If the RNDAC's rear-panel FIXED / VAR toggle switch is set to VARIABLE, then the VOLUME knob will *additionally* control the output level of the rear-panel BALANCED and UNBALANCED LINE OUTPUTS (see pg. 5 for more detail).

# RNDAC Rear-Panel Features

## XLR Balanced Output

The stereo XLR line outputs on the RNDAC are balanced by a pair of custom-wound Rupert Neve Designs transformers, achieving very low distortion while still maintaining the musical, harmonic character for which Rupert Neve is known. The XLR path is calibrated to the +4dBu nominal level standard and is capable of a maximum output level of +23.5 dBu.

## RCA Unbalanced Output

In addition to the functional utility that this second stereo analog path serves, the RCA path provides very transparent reproduction of music. The RCA output is calibrated to the -10dBV nominal level standard and is intended to connect to other RCA inputs (consumer CD Players, Home Entertainment Receivers, etc.)

## FIXED / VAR Toggle Switch

The Fixed / Variable rear-panel toggle switch is located in between the RNDAC RCA and XLR outputs. When this switch is set to the VARIABLE (Down) position, the line output volume is controlled by the RNDAC front-panel VOLUME knob. This mode of operation is most useful when the user doesn't have an external volume control between the RNDAC line outputs and their speakers.

The FIXED (Up) position should only be utilized when the user has an external volume control connected between the RNDAC line outputs and their active speakers or power amp inputs.

NOTE: In FIXED mode, the RNDAC will output **FULL-SCALE PROGRAM LEVEL**, which could potentially damage speakers or your hearing if there is no inline external volume control. If unsure about what operational mode best fits your listening setup, please contact [service@rupertneve.com](mailto:service@rupertneve.com) for more information.

## RCA Analog Input

The stereo RCA analog inputs are available to connect to other common RCA output sources such as CD players, home entertainment receivers, computer sound cards, TV analog audio outputs, etc. The RCA inputs are calibrated for the -10dBV nominal RCA standard and can accept a maximum input level of +19 dBV.

## +4 / -10 Toggle Switch

The +4 / -10 toggle switch on the RNDAC rear-panel allows the user to adjust the RNDAC Balanced stereo input to match the nominal output level of a driving source (+4 dBu or -10 dBV standard).

For example, if the user has a balanced output from a CD player that is calibrated to the -10 dBV standard, they can simply set the +4 / -10 toggle switch to the -10 setting. The more common level standard for a balanced output is typically +4 dBu nominal, so the +4 switch setting should be considered the DEFAULT position for the XLR Balanced inputs.

## XLR / TRS Analog Input

The XLR / TRS stereo analog inputs are fitted with combo jack input connectors that can accept a 1/4" TRS cable in addition to the standard 3-Pin Male XLR cable for user convenience. The Balanced analog inputs can accept the two different nominal level standards of +4 dBu and -10 dBV. This input level calibration is controlled by the position of the +4 / -10 toggle switch on the RNDAC rear-panel.

## COAX S/PDIF Input

The Coaxial S/PDIF (Sony/Philips Digital Interconnect Format) digital input is one of three (3) digital inputs available on the RNDAC. This single RCA jack is designated yellow to avoid confusion with the analog RCA inputs and outputs. This connection supports PCM playback up to 192 kHz at 24 bit resolution. When a proper COAX S/PDIF connection has been made, the RNDAC will indicate the current playback Sample Rate in PCM mode on it's front-panel.



## Optical S/PDIF Input

The Optical S/PDIF digital input is the second of three digital inputs available on the RNDAC rear-panel. Similar to the Coaxial S/PDIF connection, the Optical connection supports PCM playback up to 192 kHz at 24 bit resolution. The Optical S/PDIF connection is a common alternative found on consumer products such as home entertainment systems and televisions.

## USB Digital

The USB Audio digital input is the third of three digital inputs available on the RNDAC, made available on the USB-B port on the RNDAC rear-panel. The USB audio connection supports the following PCM and DSD rates:

PCM: 44.1 kHz, 48 kHz, 88.2 kHz, 96 kHz, 176.4 kHz, 192 kHz, and 384 kHz (up to 32 bit resolution)

DSD (Native and DoP\*\*): DSD64 (2.8 MHz / Single-Rate), DSD128 (5.6 MHz / Double-Rate), DSD256\* (11.2 MHz / Quad-Rate), and DSD512\* (22.4 MHz / Octa-Rate).

\*High-rate DSD256 (Quad) and DSD512 (Octa) are only available for playback on Windows OS.

\*\*MAC OSX can play DSD files using DSD-over-PCM (DoP) and the RNDAC supports up to DoP128 (Double-Rate DSD).

## Filter Options

The RNDAC has a five (5) position dip-switch on its rear-panel that allows the user to have control over the digital filter sets and modes internal to the AKM 4497 DAC. In the up position, the individual switch feature is INACTIVE. The dip-switch must be flipped to the DOWN position to make the DAC feature ACTIVE. The RNDAC DEFAULT setting is all dip-switches in the UP position.

While we spent a significant amount of time listening and evaluating the DAC filter options to choose a DEFAULT mode that we thought sounded best, we highly encourage the listener to experiment with different dip-switch settings to find the sonic character that best suits their individual taste and listening environment.

The functions of each of the 5 individual dip-switches are as follows (see pg. 10 for more detail):

ALL SWITCHES UP: Slow Roll-Off Filter, Standard Group Delay (RNDAC DEFAULT)

- SWITCH 1: Super-Slow Roll-Off Filter\*
- SWITCH 2: Short Group Delay Mode\*
- SWITCH 3: Sharp Roll-Off Filter\*
- SWITCH 4: AKM "High-Quality" Sound Mode\*\*
- SWITCH 5: DSD Low / High Filter Pole\*\*\*

\*Switches 1-3 only affect PCM playback

\*\*Switch 4 affects PCM and DSD playback

\*\*\*Switch 5 only affects DSD playback

RNDAC FILTER OPTION (Rear-Panel View)

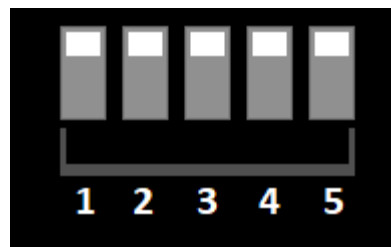

## Micro USB Firmware Update

NOTE: The Micro USB port on the RNDAC is solely intended for Firmware Updates. This port is **NOT** intended for streaming USB audio at any point from any device. See pg. 11 for more detail on RNDAC firmware updates.

## AC Power Entry

The AC Mains Power Entry receptacle on the RNDAC rear-panel is designed to accept a standard IEC 3-Pin power cable. The Power ON/OFF switch is located just above the AC power inlet on the RNDAC rear-panel.

# RNDAC USB Audio Setup

## RNDAC Initial USB Connection for Windows

The first time the RNDAC is plugged into your Windows PC, you will need to install the necessary drivers to properly enable the RNDAC features.

1. Visit [fidelice.com](http://fidelice.com) and download the RNDAC Windows driver installer listed on the RNDAC product page.
2. Once the driver download is finished, run "rndac\_driver.exe" to install the drivers on your PC.
3. After installation is complete, Windows should notify that the driver is "Ready to Use."

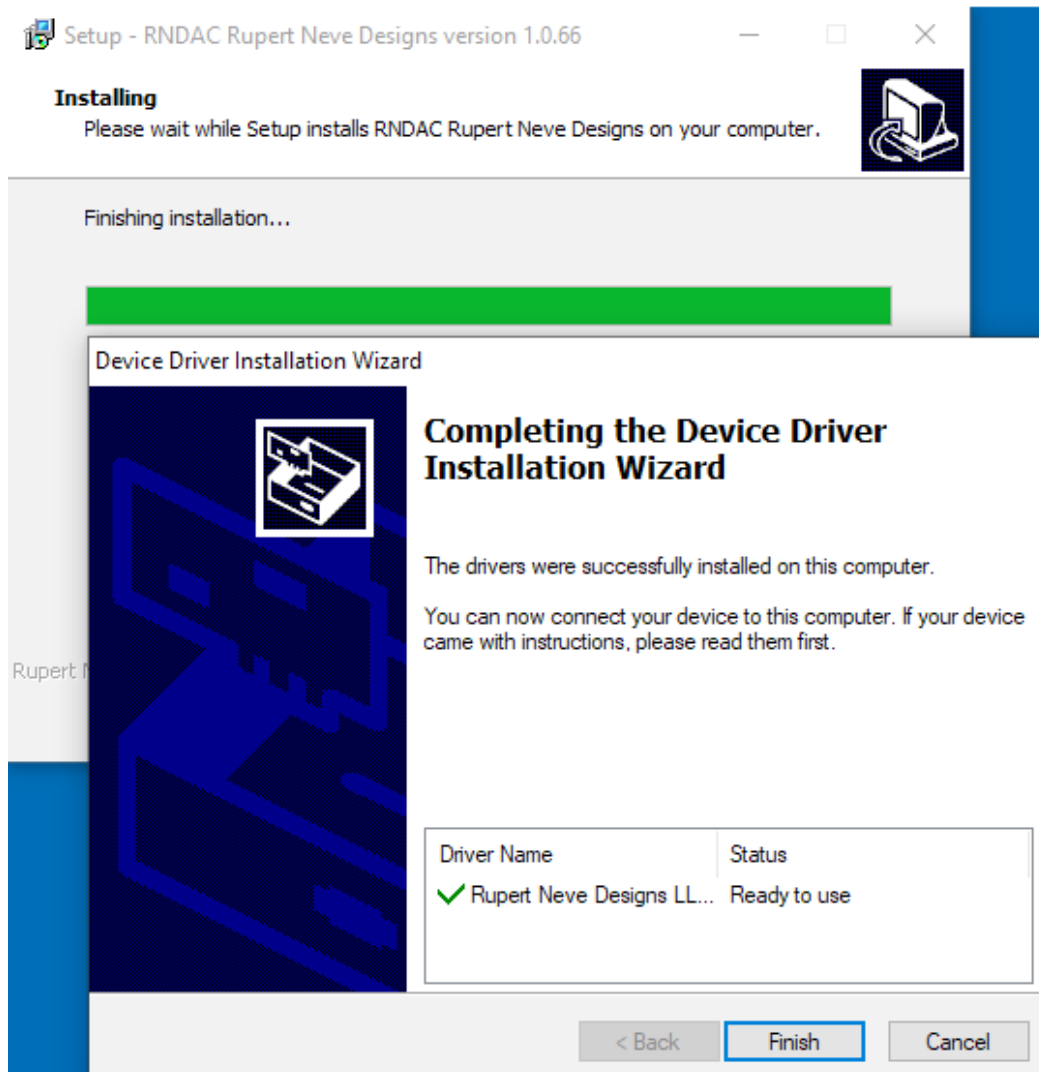

4. Click Finish. The RNDAC should be ready to stream USB audio. If you are still experiencing playback issues, please contact [service@rupertneve.com](mailto:service@rupertneve.com) for support.

## RNDAC Initial USB Connection for Mac

There is no necessary driver install for Mac OS. Connect the RNDAC to your Mac using the included USB-A to USB-B cable and enjoy!

## USB Playback Sample Rate Configuration

It is important to understand that some media players (such as Tidal and JRiver Media Center) output the correct USB control transfer data to notify the RNDAC to change sample rate based on the source file. However, some media players do not output this data. In this case, the user can manually adjust the RNDAC sample rate. Windows and Mac OS have different methods:

### Sample Rate Configuration (Windows)

1. Navigate to Windows "Sound" Preferences (Control Panel > Hardware and Sound). Shortcut: Right-click on the speaker icon in the Windows task bar (lower right corner of your screen). Click on "Playback Devices" in the pop-up menu.



2. Windows "Sound" Preferences will open. Double-click on the "(Digital Output) 2- RNDAC" under the "Playback" tab.

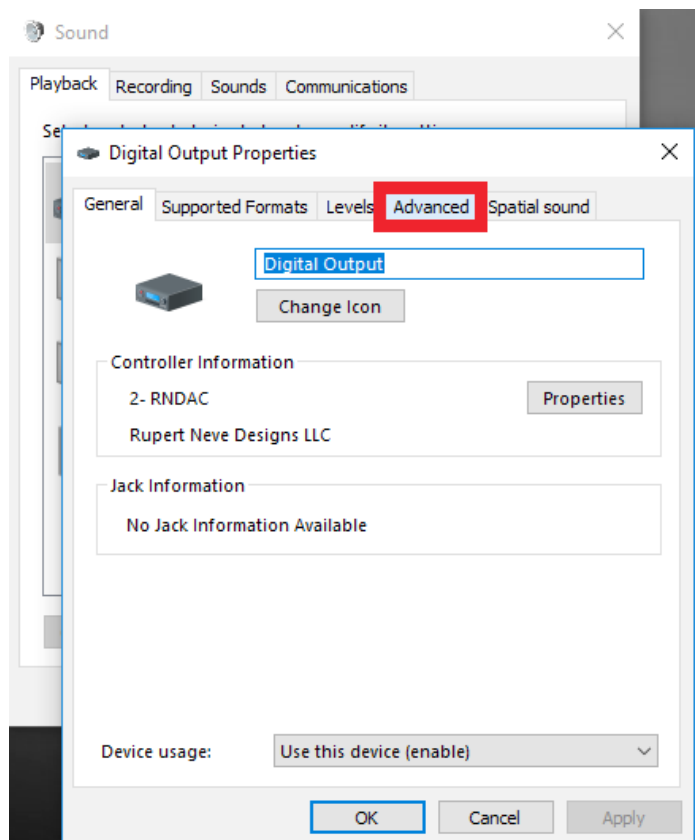
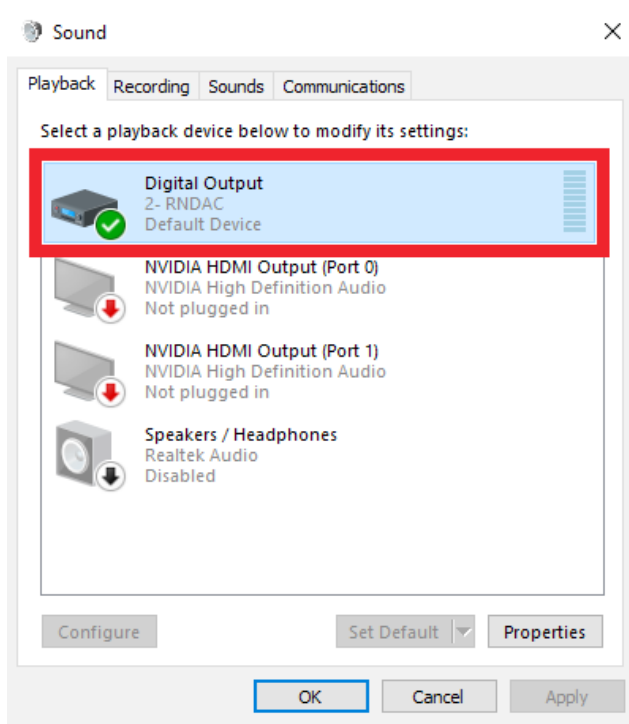

4. Navigate to the “Advanced” tab. The “Advanced” menu allows the user to manually configure the sample rate. Select a Sample Rate from the drop-down list and then click “OK.” Playback may be momentarily interrupted.

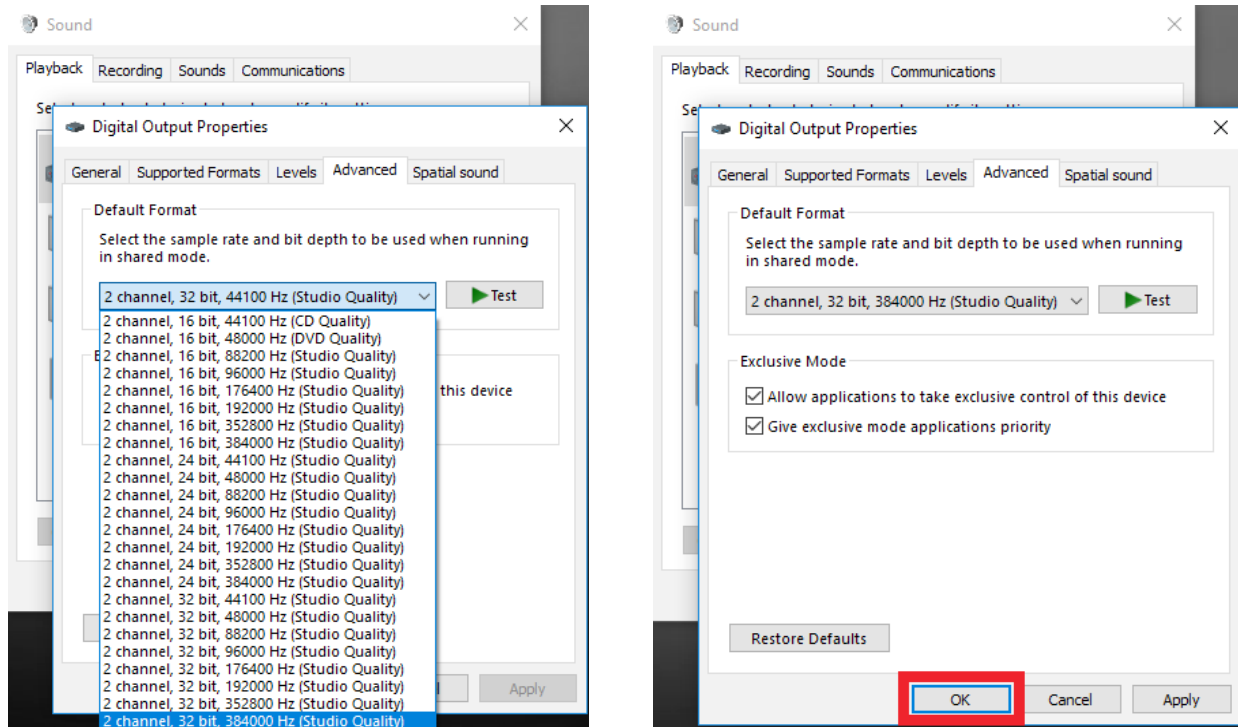

### Sample Rate Configuration (Mac)

1. Navigate to Go > Utilities on the Mac Finder Menu Bar (or press Shift-Command-U). Double-click on Audio MIDI Setup. The Audio Devices Window should pop-up (if not press Command 1 to unhide the Audio Devices Window).

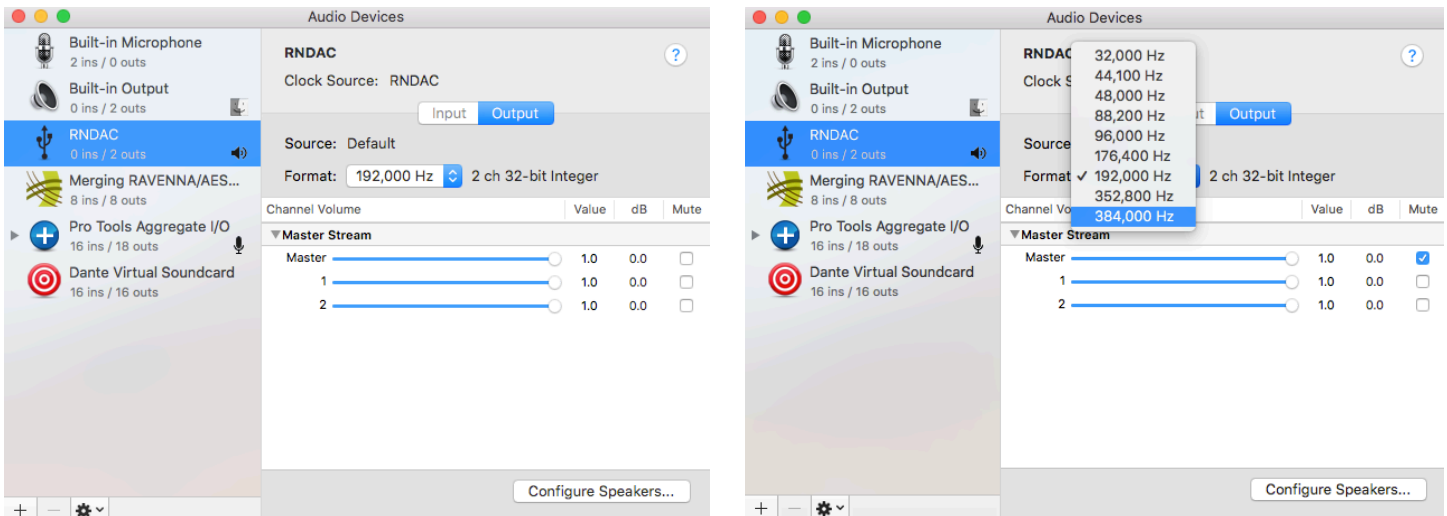

2. Click on the RNDAC in the audio device sidebar to select its properties. Under the “Format” drop-down menu, the user can manually select the Sample Rate. Playback may be momentarily interrupted.

# DSD Playback

The RNDAC is capable of PCM and DSD playback. PCM (Pulse-Code-Modulation) is by far the most common form of digitally encoded music, however, DSD (Direct-Stream-Digital) is enjoying increased attention from the hi-fi community.

Both formats approach audio encoding with different methodologies, and each format has its supporters. It was important that we built in the capability for high-quality PCM and DSD playback within the RNDAC, ultimately allowing the user to decide which format they prefer.

Based on our testing, we recommend using JRiver Media Center for DSD playback. We found, overall, that JRiver Media Center performed most reliably on Windows and Mac at all DSD rates, in most cases requiring minimal additional software configuration. Other media players may require additional preference configuration for DSD playback.

## Digital Filter Options

The RNDAC's Filter Options are available on the rear-panel five (5) position dip-switch. The feature is ON when the dip-switch is in the DOWN position. There are three separate filter options: Slow Roll-Off, Super-Slow Roll-Off and Sharp Roll-Off (see frequency response graphs on pg. 19-20). In addition to three filter modes, Switch 2 allows the user to switch between two different Group Delay modes (short vs. standard). Switch 4 allows the user to toggle AKM's "High-Quality Sound" mode ON/OFF and Switch 5 picks between the low or high-pole filter for DSD playback. The RNDAC's available digital mode combinations are shown below:

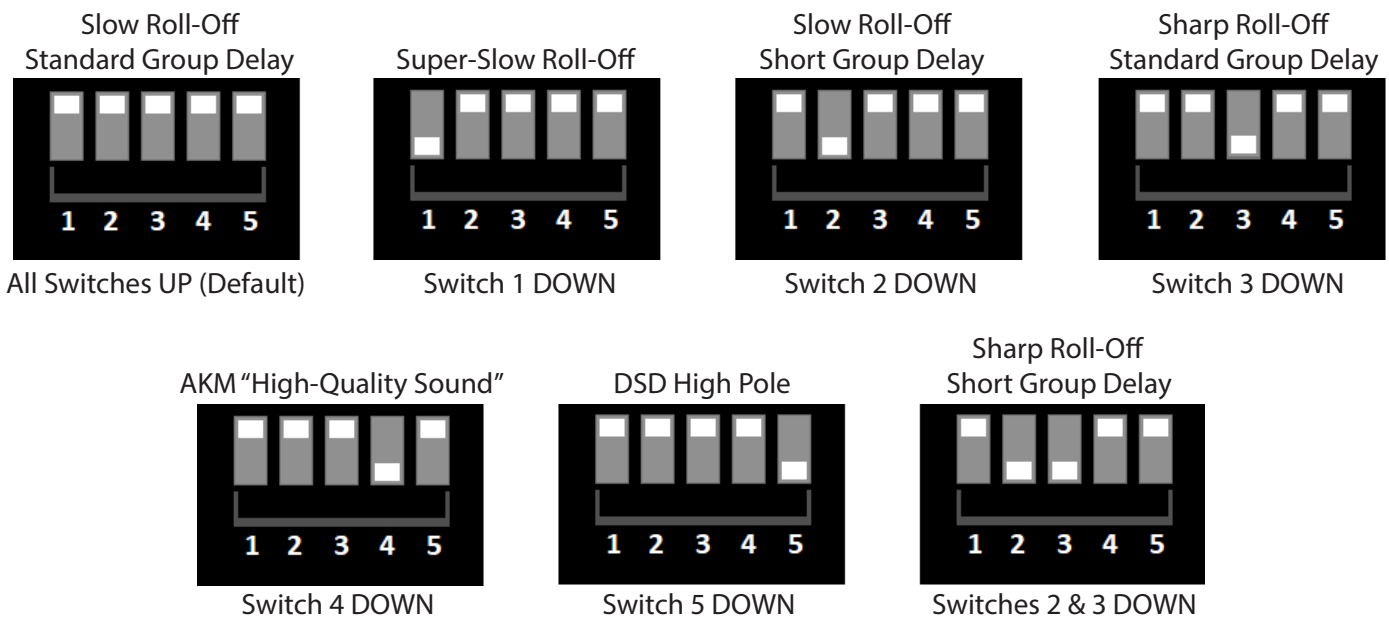

All Switches UP (Default): Slow Roll-Off Filter, Standard Group Delay (PCM Only)

Switch 1: Super-Slow Roll-Off Filter (PCM Only)

Switch 2: Short Group Delay (PCM Only)

Switch 3: Sharp Roll-Off Filter (PCM Only)

Switch 4: AKM DAC "High-Quality Sound" Mode (PCM and DSD)

Switch 5: Low / High Pole DSD Filter (DSD Only)

# RNDAC Micro-USB Firmwate Update

In the event that the RNDAC needs to have its firmware updated, follow this procedure:

## **Windows PC**

For RNDAC firmware updates using a Windows PC, you will need to install the FTDI driver, USB Bootloader (Unified Host Bootloader 0.1.14) and Java 8 Runtime Environment.

These installers are included within the RNDAC\_Firmware\_Update\_v23.zip download available on the Fidelice website ([www.fidelize.com](http://www.fidelize.com)).

Step 1: Run the FTDI driver installer ("CDM21228\_Setup") and complete the installation, following the on-screen prompts.

Step 2: Run the Java 8 Runtime Environment Installer and complete the installation, following the on-screen prompts.

*Note:* You will need to take note of the COM port number in Device Manager. This information will be needed later when configuring the Unified Host Bootloader for the RNDAC firmware update.

## **Mac**

RNDAC firmware update using a Mac does not require the FTDI driver installer, but you may need to install the Java Runtime environment if it is not already installed in order to run the Unified Host USB Bootloader.

Step 1: Run the Java 8 Runtime Environment Installer and complete the installation, following the on-screen prompts.

*Note:* Mac does not require that the user looks up the COM port ahead of time. It will be the only available port in the Unified Bootloader drop down menu.

## **Troubleshooting:**

WINDOWS 10 - Unified Host Bootloader 1.14 unexpectedly quits when applying COM port changes.

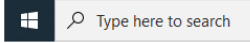
- Type "Add or Remove Programs" into Windows Taskbar Search 
- In the "Apps" list, scroll down to find "Java 8 Update 361 (64-bit)" and click "Uninstall"
- Re-open Unified Host Bootloader 1.14 and repeat Steps 1-14.

## **RNDAC Firmware Update Procedure:**

Now that you have installed the necessary components for your computer configuration, please continue with the following instructions.

1. Start with the RNDAC powered OFF.
2. Connect a USB-Micro to USB-A cable between your computer and the RNDAC rear-panel USB Firmware Update port but DO NOT power ON the RNDAC. For Mac, skip ahead to step 5.
3. (Windows PC Only) BEFORE turning on the RNDAC, open the Device Manager. Locate "Ports (COM & LPT)" in the device manager list and click on the drop-down arrow to show the available COM ports.

*Note:* While the Micro USB Firmware update port is connected to a computer during the update process, the RNDAC front panel will not illuminate while powered ON. This is normal operation during firmware update.

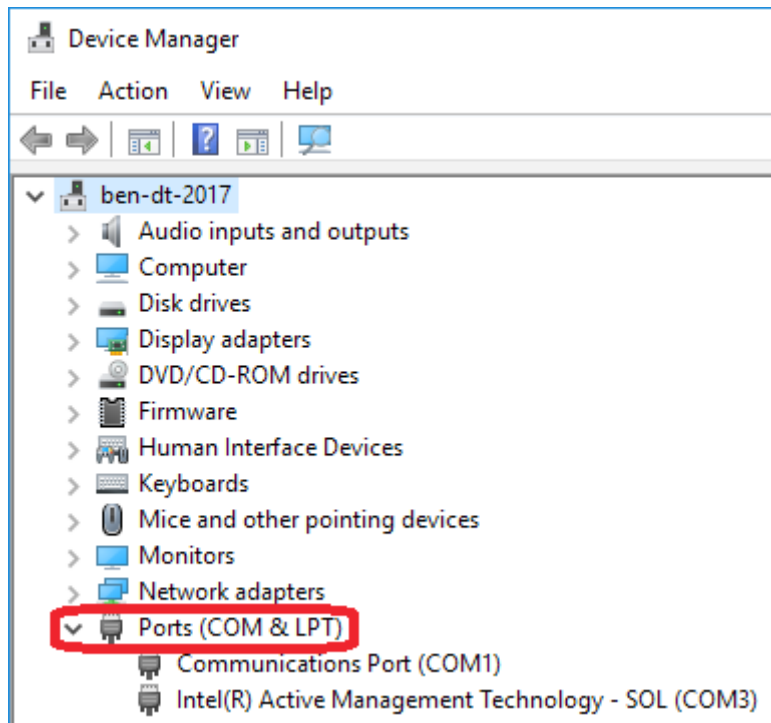

4. (Windows PC Only): With Device Manager still open, power ON the RNDAC and wait for a new COM port to show up in the drop-down list. Note the COM port number for later use (in the example below it's COM7).

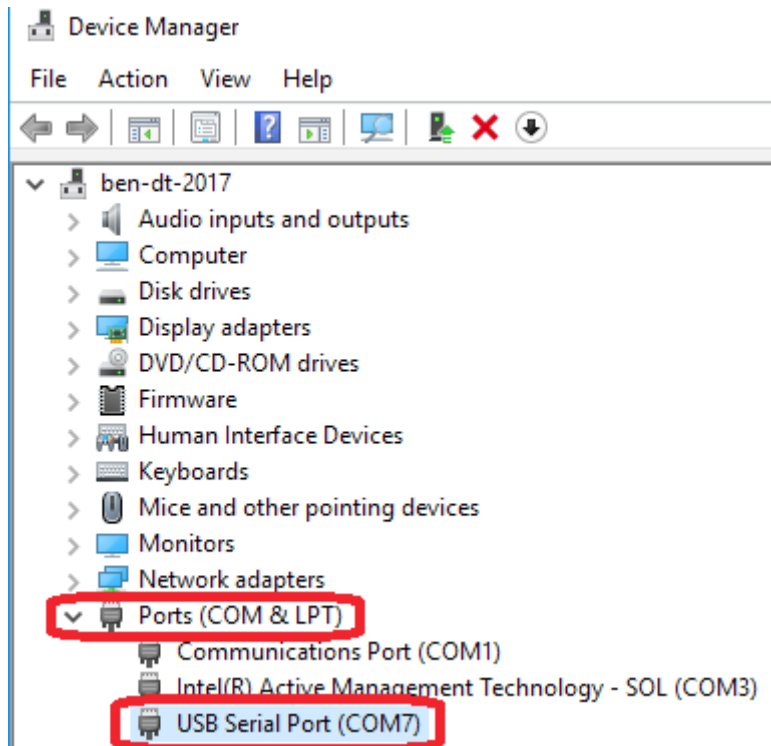

5. Open the RNDAC Bootloader: UnifiedHost-0.1.14. The following window will pop-up.

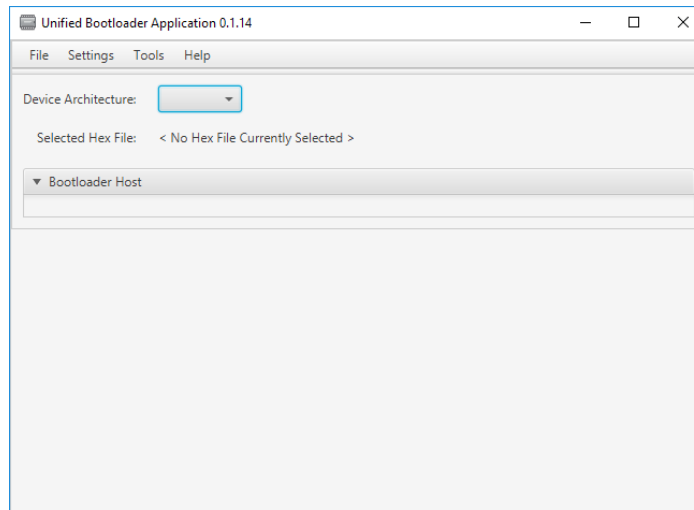

6. Click on the "Device Architecture" drop-down box and select **8-bit**. Once 8-bit architecture is selected, the Bootloader window will refresh with more configuration options. You may need to resize the window at this point to see the full configuration window.

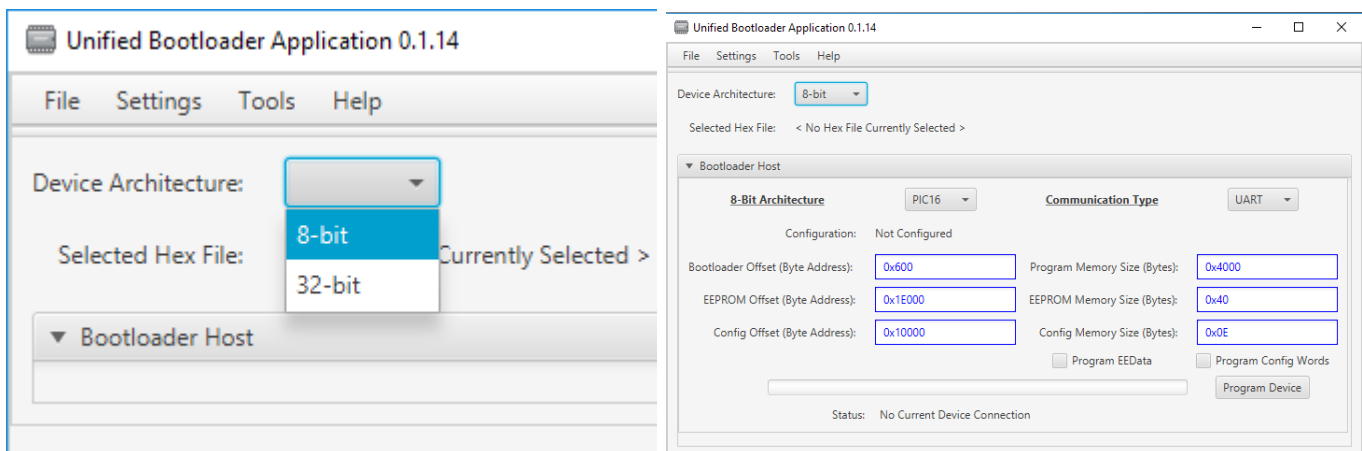

7. Click on File > Open/Load File (\*.hex). Navigate to the directory where you saved the image hex file and click OK. Once the image hex file has been loaded, it will be indicated in the RNDAC bootloader under "Selected Hex File."

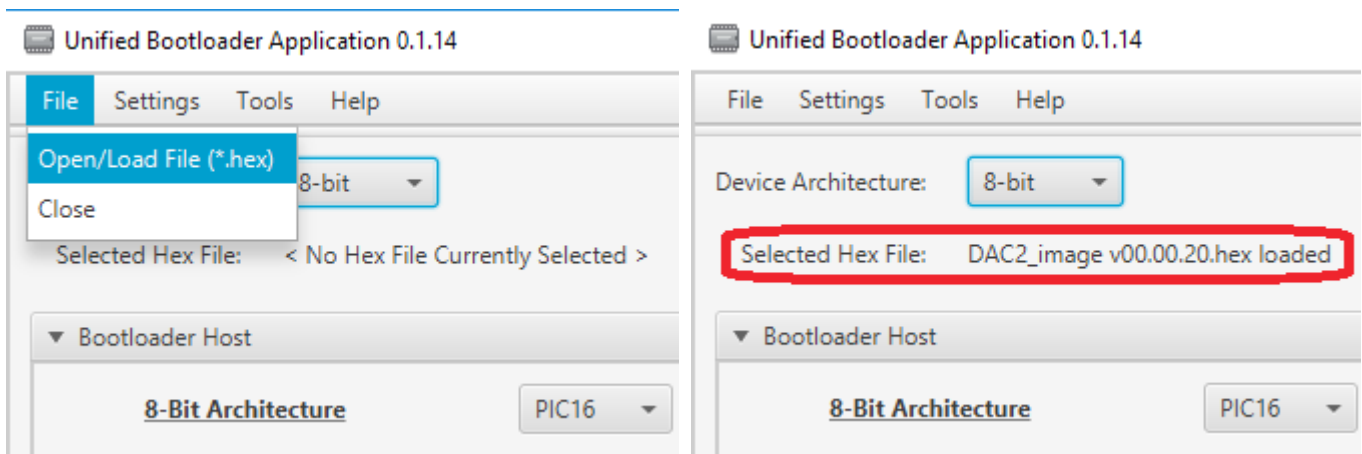



8. Navigate to the "Settings" tab. Click on "Serial" within the settings drop-down menu. A new panel will pop-up.

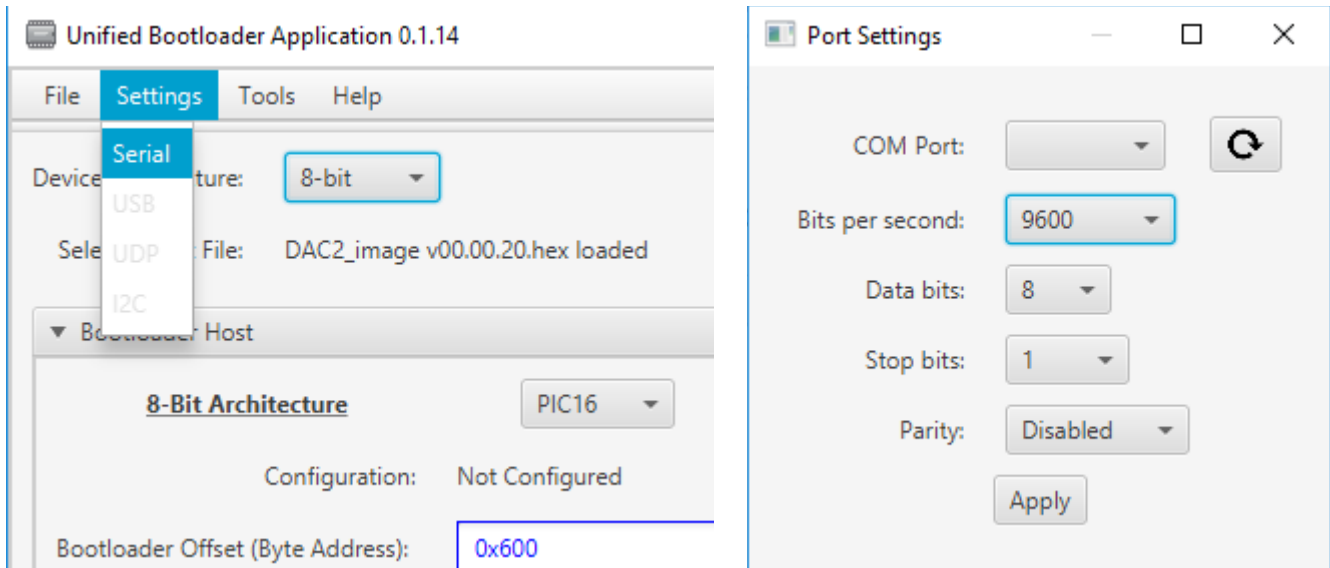

9. Click on the COM Port drop-down menu. Select the COM Port Number you referenced in Step 4 (in this example: COM7). Next, click on the "Bits per second" drop-down menu and select "57600." After both of these parameters have been selected, click "Apply". Double-check the "Configuration" section to confirm correct settings.

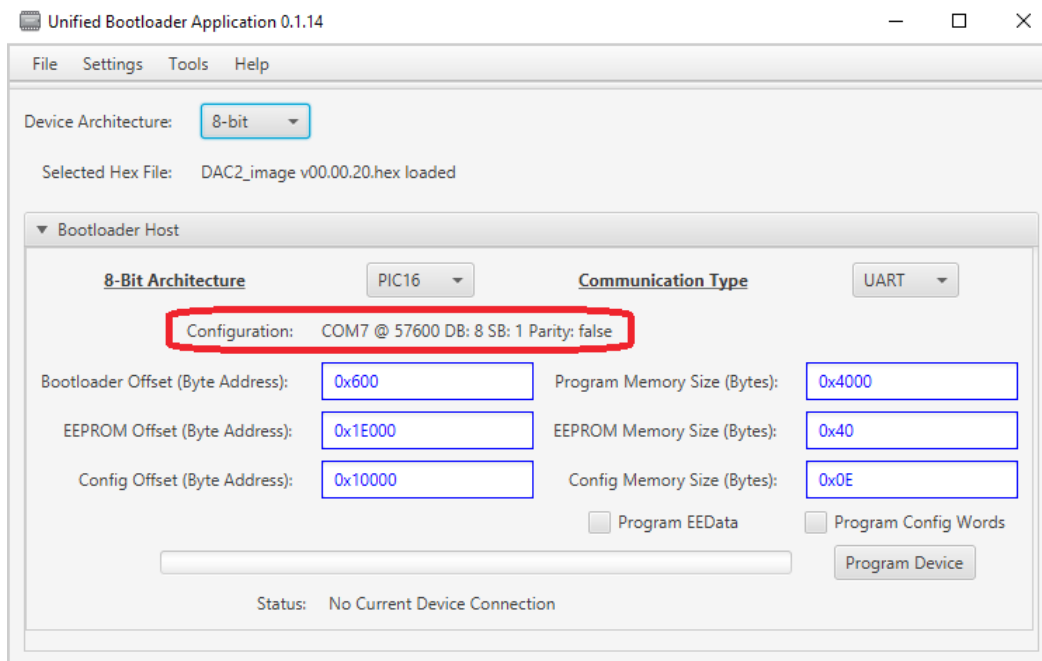
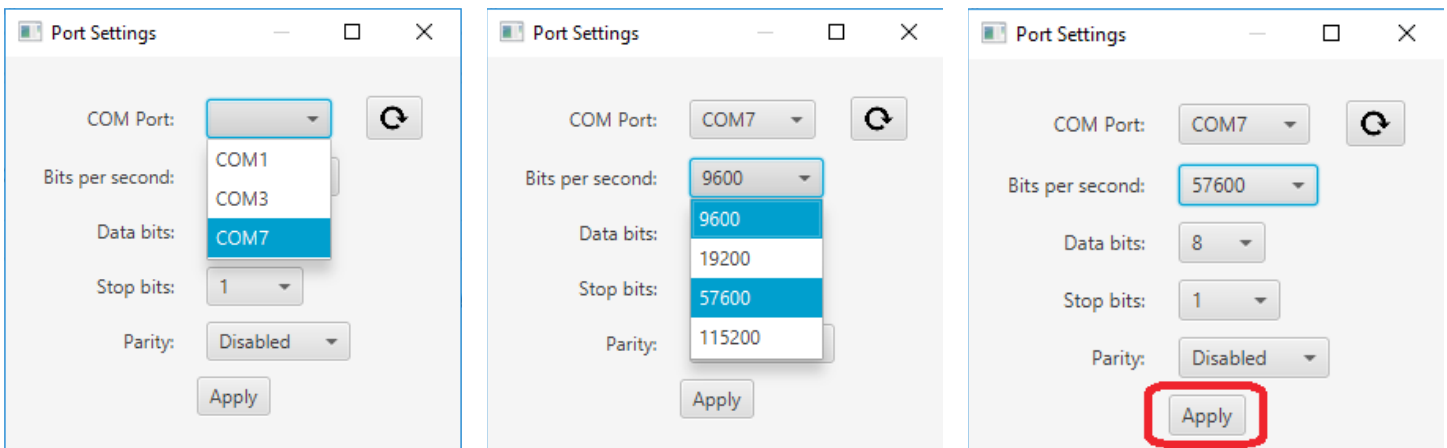

10. Manually change the “Bootloader Offset (Byte Address)” to read: **0xA00**

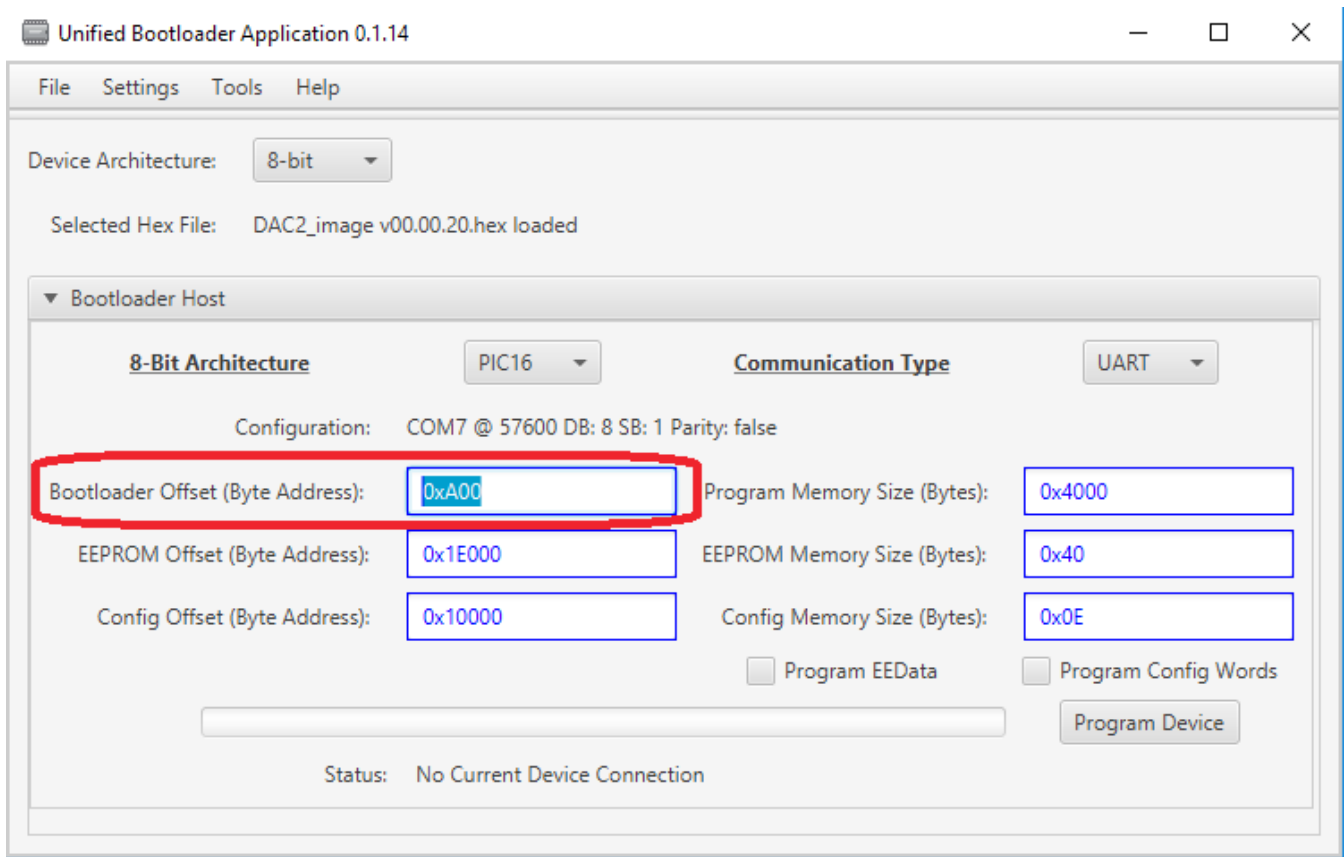

11. Click on the “Program Device” button in the bottom right corner. If a successful connection is made, you will see the “Status” change to “Device Connected Successfully” and the firmware update will commence.

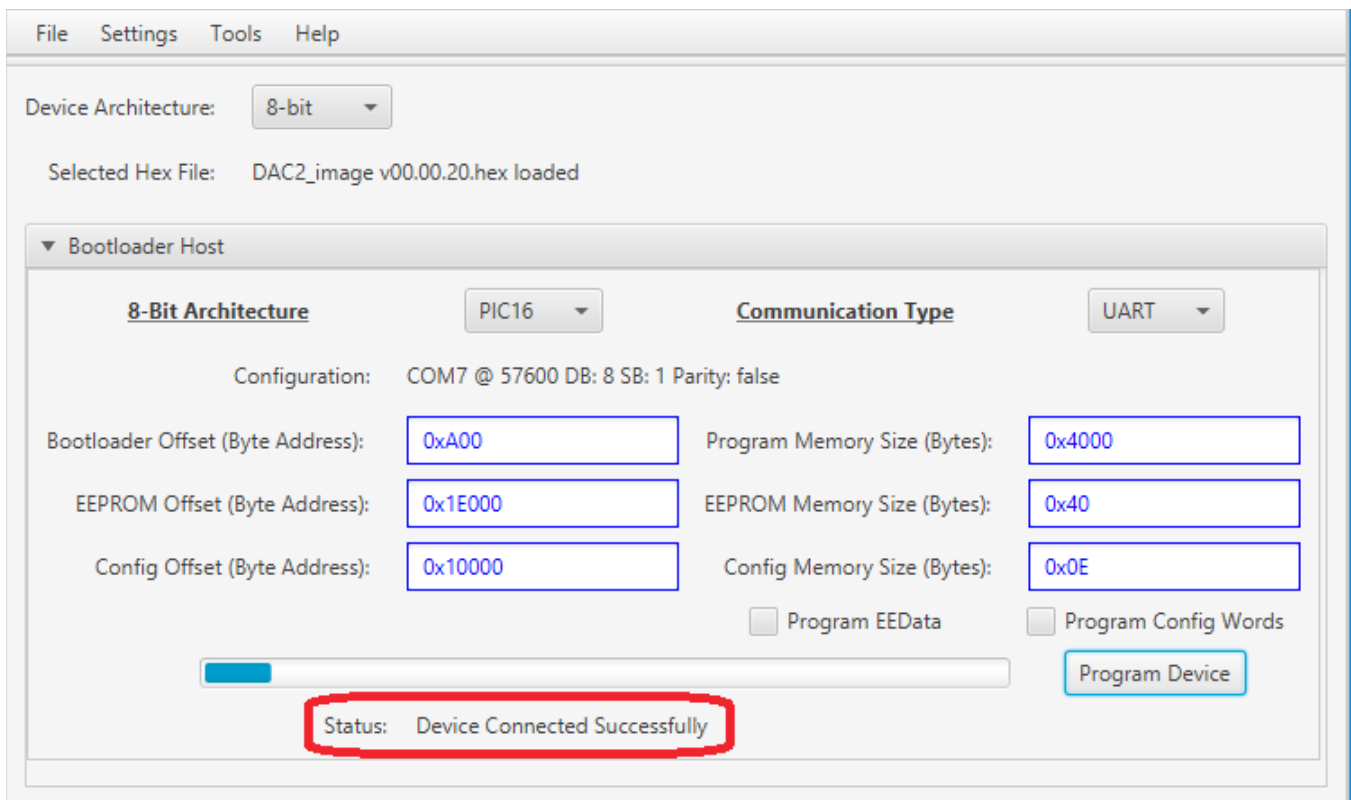

12. Once complete, the Status will change to "Disconnected after Programming was Successful." At this point, close the bootloader, power OFF the RNDAC, and disconnect the Micro USB cable.

13. To confirm that the RNDAC has been successfully updated, power ON the RNDAC. The front panel tactile switches will illuminate to indicate the current firmware version. See example below.

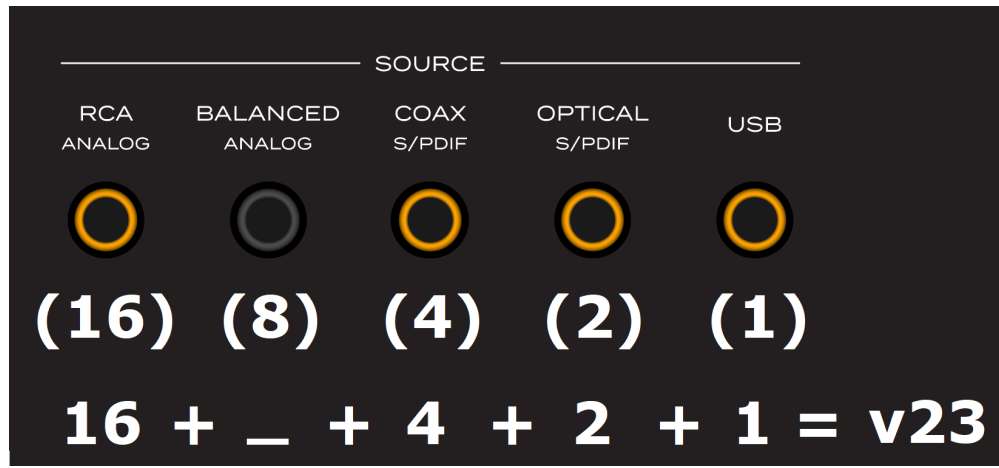

14. If the front panel indicates the correct firmware version, then the update process is complete and normal use can resume.

# RNDAC Specifications

## Analog Path Specifications

### Balanced XLR Input to Balanced XLR Output (FIXED Volume)

$Z_{SOURCE} = 40 \Omega$  Balanced with 30 ft Output XLR

Input Impedance	10 k $\Omega$
Output Impedance	40 $\Omega$
Maximum Input Level (+4dBu Selected)	+23.5 dBu
Maximum Output Level	+23.5 dBu
Noise @ FIXED Volume (10 Hz - 22 kHz BW)	-101.2 dBV typical
Frequency Response (5 Hz to 116 kHz)	+/- 0.1 dB typical
THD+N @1 kHz (10 Hz - 22 kHz BW)	0.0005% typical

### Unbalanced RCA Input to Unbalanced RCA Output (2V RMS Redbook)

$Z_{SOURCE} = 470 \Omega$  Unbalanced

Input Impedance	10 k $\Omega$
Output Impedance	33 $\Omega$
Maximum Input Level	+19.2 dBV
Maximum Output Level	+19.2 dBV
Noise @ FIXED Volume (10 Hz - 22 kHz BW)	-109 dBV typical
Frequency Response (5 Hz to 112 kHz)	+/- 0.1 dB typical
THD+N @1 kHz (10 Hz - 22 kHz BW)	0.0003% typical

### Balanced Input to Unbalanced Headphone Output

$Z_{SOURCE} = 40 \Omega$  Balanced

Input Impedance	10 k $\Omega$
Output Impedance	0.01 $\Omega$
Noise @ Max Volume (10 Hz - 22 kHz BW)	-98.2 dBV typical
Frequency Response (5 Hz to 200 kHz)	+/- 0.2 dB typical
THD+N (1W into 36 $\Omega$ Load @1 kHz, BW 10Hz - 22 kHz)	0.003% typical
THD+N (1W into 16 $\Omega$ Minimum Load @ 1 kHz, BW 10Hz - 22 kHz)	0.006% typical

## Digital Path Specifications

### Coaxial S/PDIF Input to Balanced XLR Output (FIXED Volume)

192 kHz SR with Slow Roll-Off Filter

Noise (10 Hz - 22 kHz BW)	-96.2 dBV typical
Frequency Response (5 Hz to 23 kHz)	+/- 0.1 dB typical
Passband (0.5 Hz to 90 kHz)	-3dB typical
THD+N @1 kHz (10 Hz - 22 kHz BW)	0.0004% typical

### Coaxial S/PDIF Input to Unbalanced RCA Output (FIXED Volume)

192 kHz SR with Slow Roll-Off Filter

Noise (10 Hz - 22 kHz BW)	-107 dBV typical
Frequency Response (5 Hz to 20 kHz)	+/- 0.1 dB typical
Passband (0.5 Hz to 90 kHz)	-3dB typical
THD+N @1 kHz (10 Hz - 22 kHz BW)	0.0004% typical

**Coaxial S/PDIF Input to Unbalanced Headphone Output****192 kHz SR with Slow Roll-Off Filter**

Output Impedance	0.01 $\Omega$
Noise @ Max Volume (10 Hz - 22 kHz BW)	-95.2 dBV typical
Frequency Response (5 Hz to 20 kHz)	+/- 0.1 dB typical
Passband (0.5 Hz to 90 kHz)	-3dB typical
THD+N (1W into 16 $\Omega$ Minimum Load @1 kHz, BW 10 Hz - 22kHz)	0.006% typical

**Coaxial S/PDIF Input to Balanced Headphone Output****192 kHz SR with Slow Roll-Off Filter**

Output Impedance	0.02 $\Omega$
Noise @ Max Volume (10 Hz - 22 kHz BW)	-89.2 dBV typical
Frequency Response (5 Hz to 20 kHz)	+/- 0.1 dB typical
Passband (0.5 Hz to 90 kHz)	-3dB typical
THD+N (1W into 16 $\Omega$ Minimum Load @1 kHz, BW 10 Hz - 22 kHz)	0.008% typical

Shipping Weight 12 lbs (5.5 kg)

Shipping Dimensions 21.75" (55.2 cm) x 16.42" (41.7 cm) x 5.63" (14.3 cm)

AC Power Cord Type IEC Standard 3 Pin 18 AWG Type

AC Power Consumption 45W Max

### Analog Frequency Response - Balanced In to Balanced Out ( $Z_{SOURCE} = 40 \Omega$ Balanced, 30 ft. Output XLR)

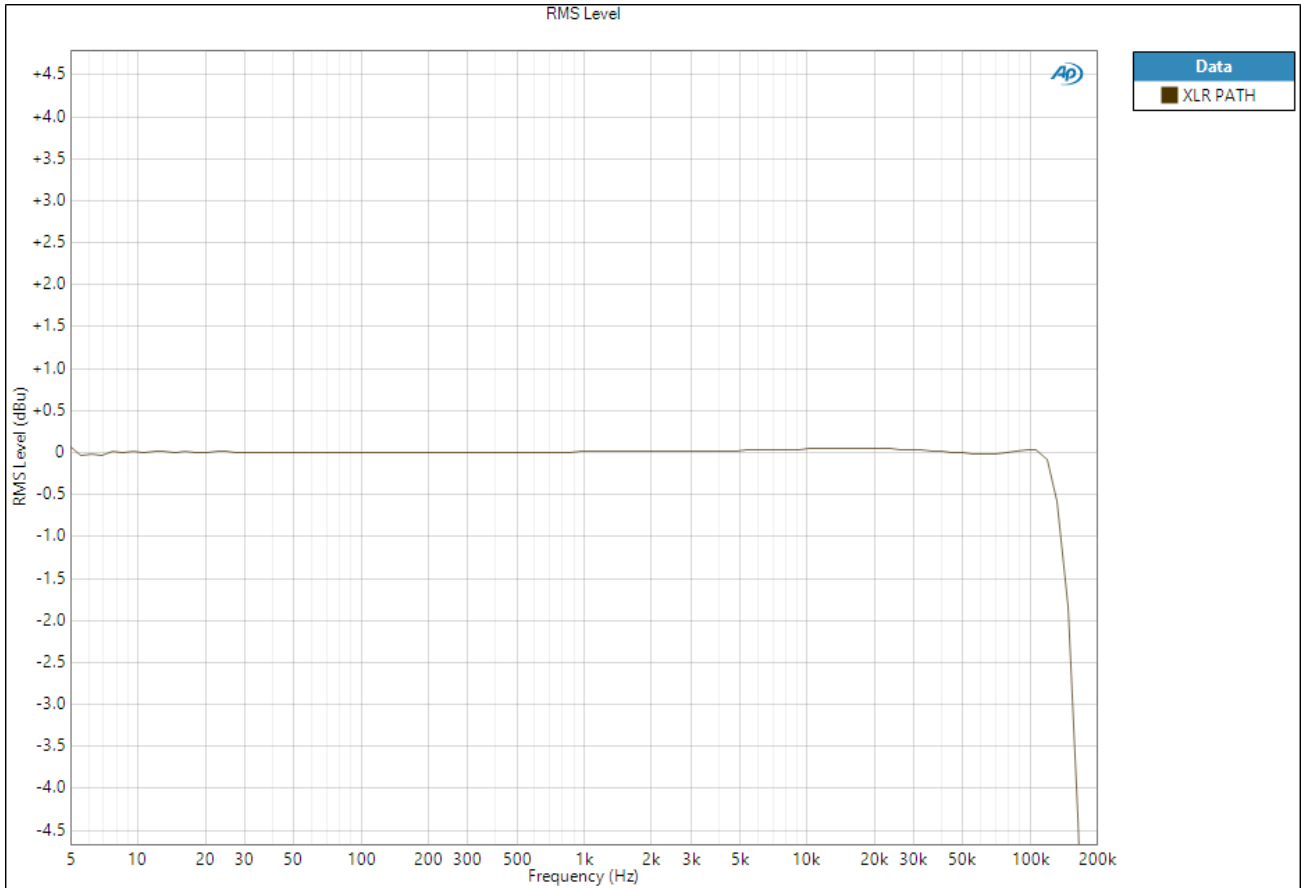

### Analog Frequency Response - Unbalanced In to Unbalanced Out ( $Z_{SOURCE} = 470 \Omega$ Unbalanced)

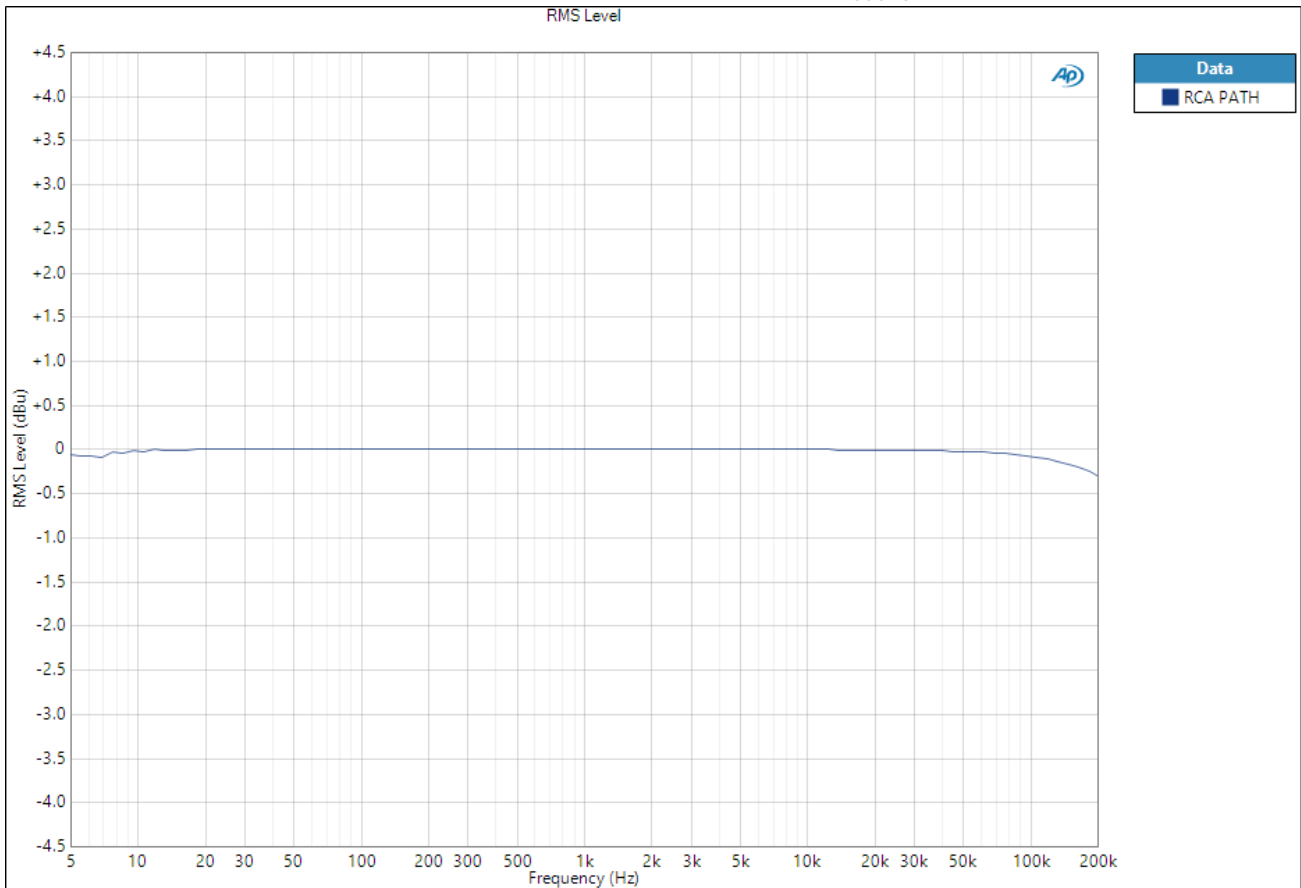

### Analog Frequency Response - Balanced In to Unbalanced Headphone Out ( $Z_{SOURCE} = 40 \Omega$ Bal, $Z_{LOAD} = 16 \Omega$ )

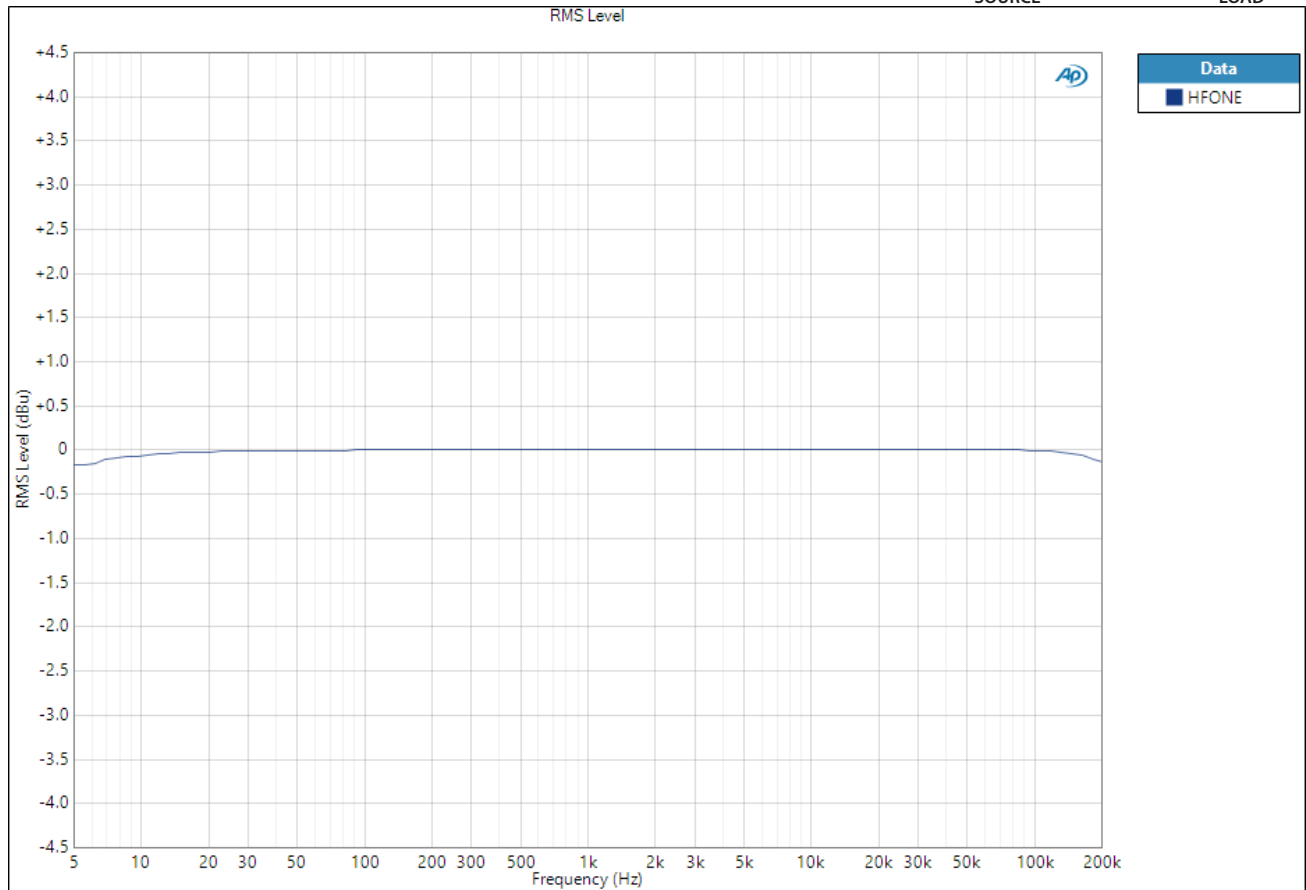

### Digital Filter Frequency Response - 192kHz SR COAX S/PDIF In to Balanced Out

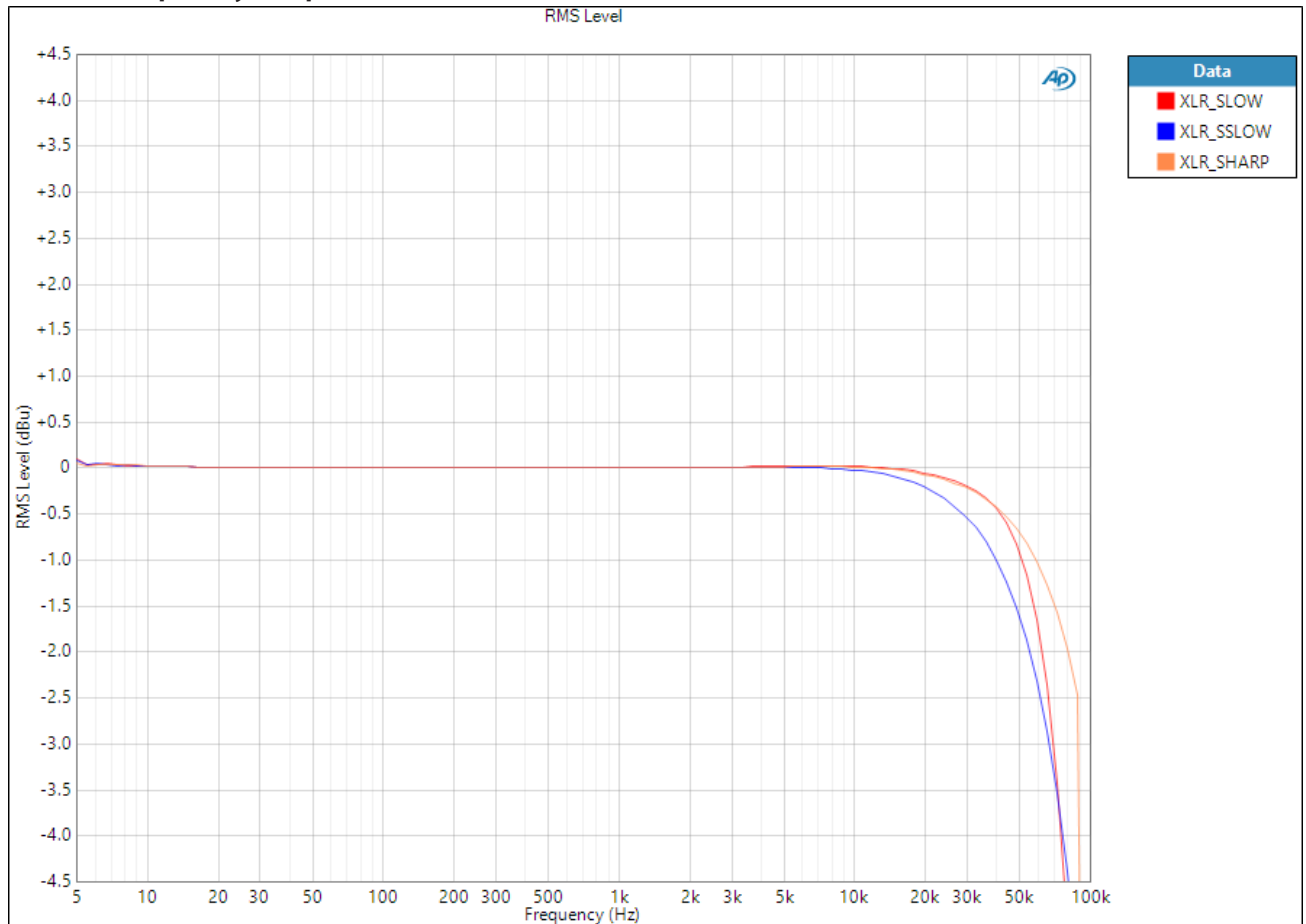

## Digital Filter Frequency Response - 192kHz SR COAX S/PDIF In to Unbalanced Out

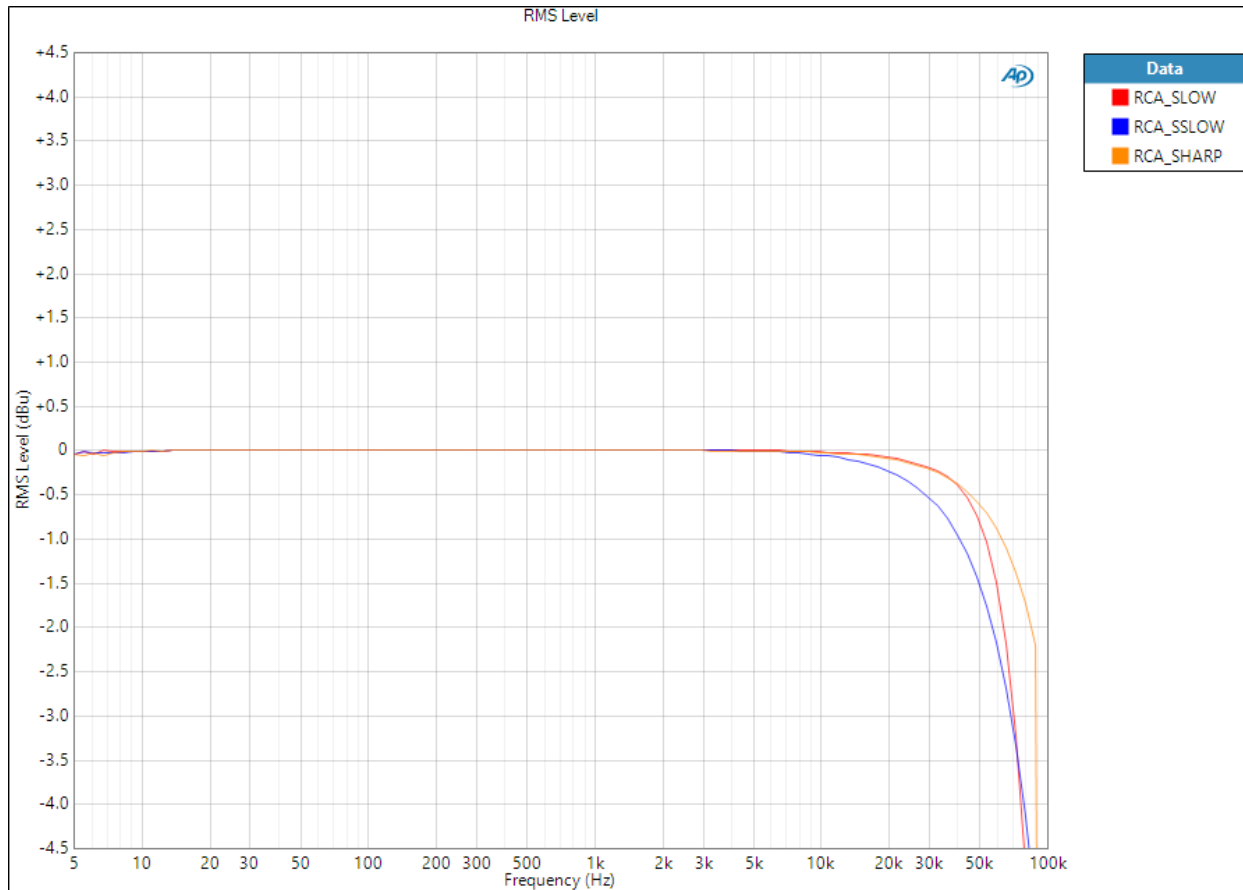

## Digital Filter Frequency Response - 192kHz SR COAX S/PDIF In to Unbalanced Headphone Out

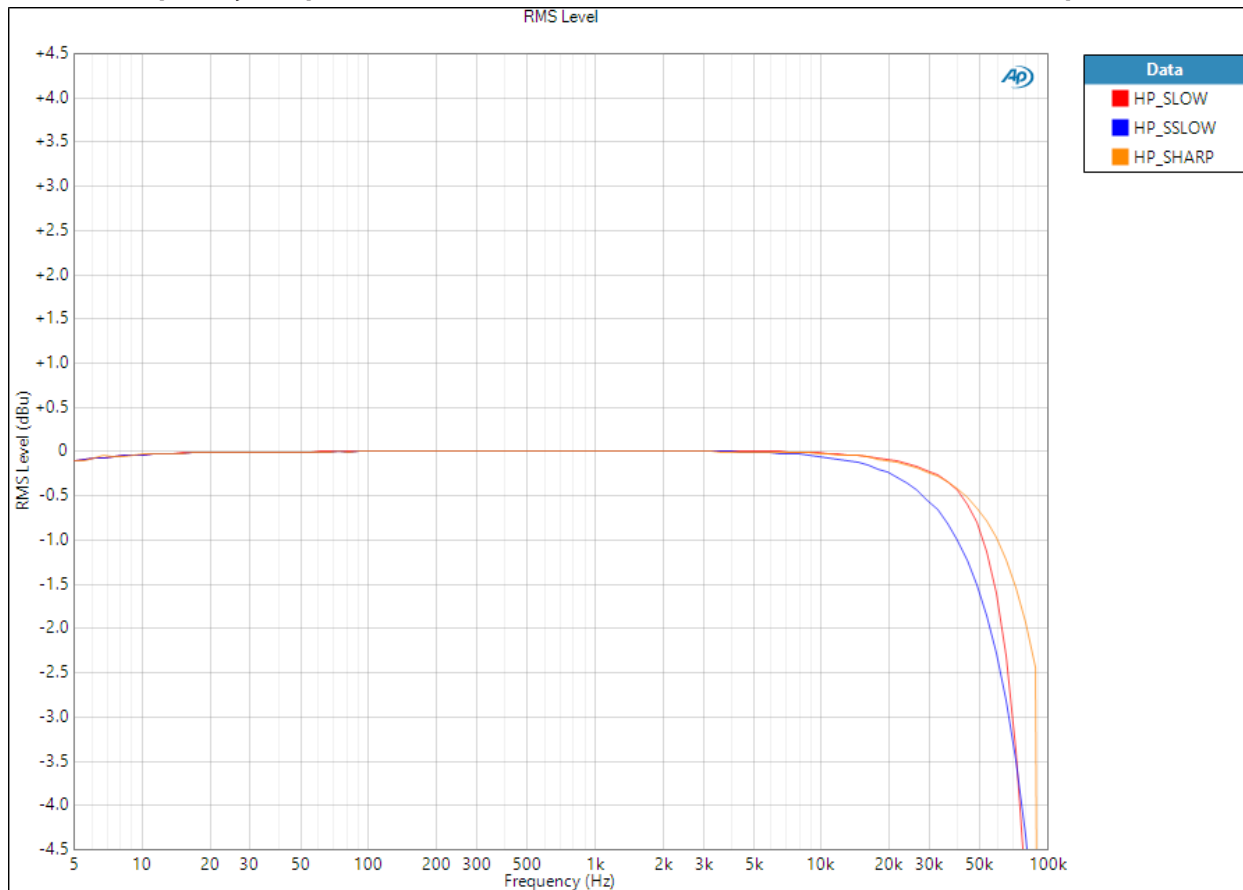



# Digital Filter Frequency Response - 192kHz SR COAX S/PDIF In to Balanced Headphone Out ( $Z_{LOAD} = 16 \Omega$ )

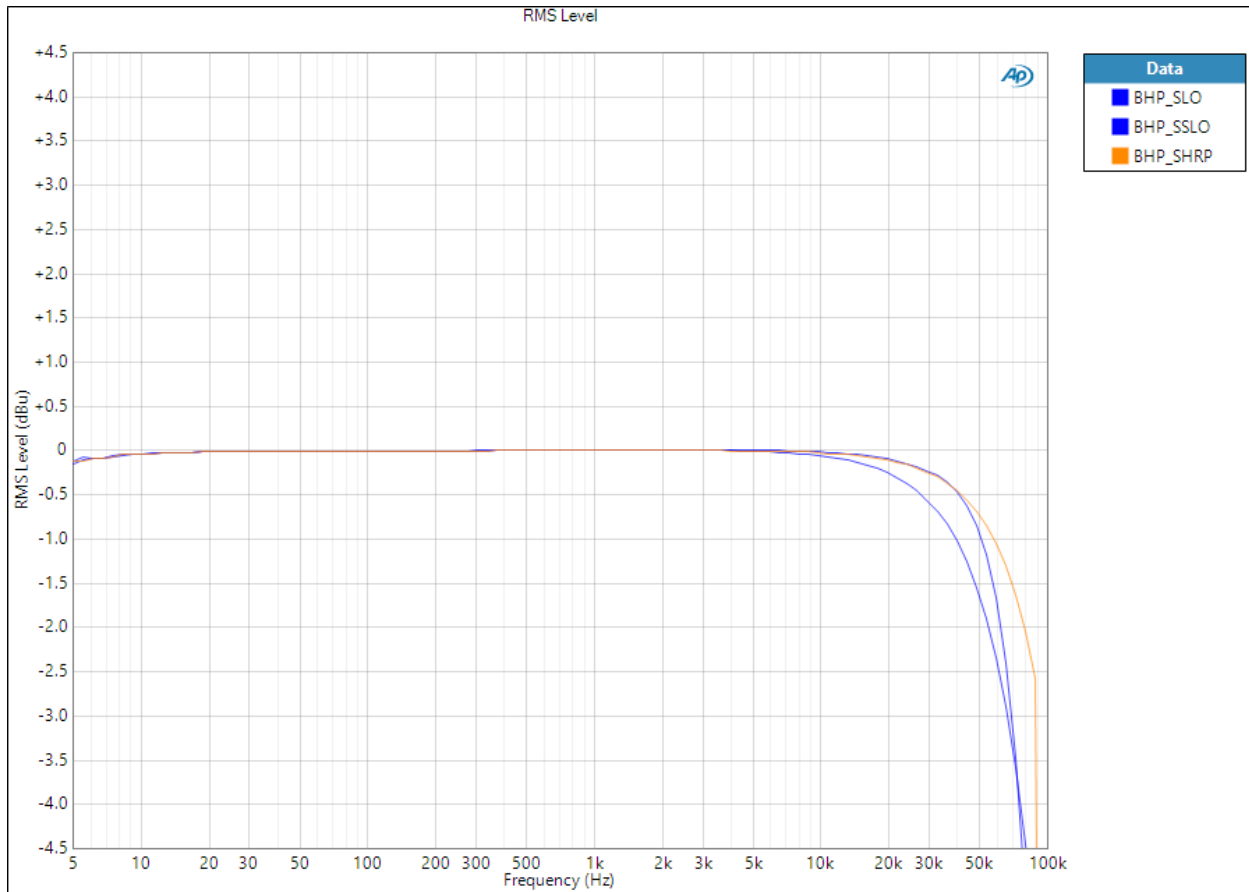

# 192kHz SR COAX S/PDIF In - Unbalanced vs. Balanced Headphone Out Frequency Response

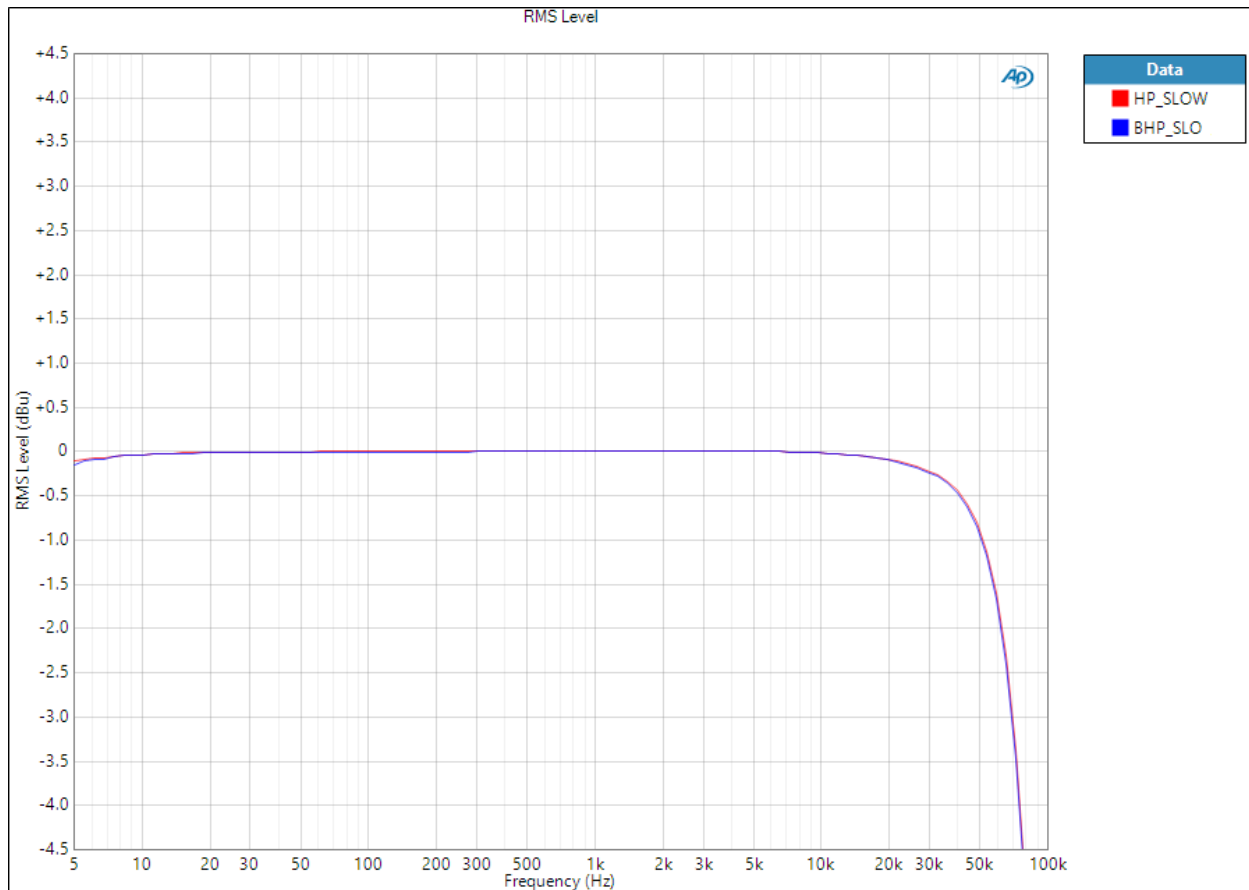

## **PRODUCT WARRANTY**

Rupert Neve Designs warrants this product to be free from defects in materials and workmanship for a period of three (3) years from date of purchase, and agrees to remedy any defect identified within such three year period by, at our option, repairing or replacing the product.

## **LIMITATIONS AND EXCLUSIONS**

This warranty, and any other express or implied warranty, does not apply to any product which has been improperly installed, subjected to usage for which the product was not designed, misused or abused, damaged during shipping, damaged by any dry cell battery, or which has been altered or modified in any way. This warranty is extended to the original end user purchaser only. A purchase receipt or other satisfactory proof of date of original purchase is required before any warranty service will be performed. THIS EXPRESS, LIMITED WARRANTY IS IN LIEU OF ALL OTHER WARRANTIES, EXPRESS OR IMPLIED, TO THE EXTENT ALLOWED UNDER APPLICABLE STATE LAW. IN NO EVENT SHALL RUPERT NEVE DESIGNS BE LIABLE FOR ANY SPECIAL, INCIDENTAL, OR CONSEQUENTIAL DAMAGES RESULTING FROM THE USE OF THIS PRODUCT. Some states do not allow the exclusion or limitation of consequential damages or limitations on how long an implied warranty lasts, so this exclusion may not apply to you.

## **WARRANTY SERVICE**

If you suspect a defect in this product, please call us at 512-847-3013 or contact our support staff (service@rupertneve.com) for troubleshooting. If it is determined that the device is malfunctioning, we will issue a Return Material Authorization and provide instructions for shipping the device to our service department.



### **Rupert Neve Designs**

PO Box 1969

Wimberley TX 78676

[www.rupertneve.com](http://www.rupertneve.com)

tel: +1 512-847-3013

fax: +1 512-847-8869